

Birch

Natural Birch is a medium density hardwood with a fine, moderate grain pattern. The predominant sapwood color is white to creamy yellow, while the heartwood varies in color from medium or dark brown to reddish brown. This range in color makes a distinctive statement in your Birch cabinetry selection.

Premium Antique Glaze Finishes

(available with an upcharge)

Antique Chocolate w/Mocha Glaze

Premium Burnished Finishes

(available with an upcharge)

Burnished Rye *

Burnished Cinnamon *

Premium Highlight Finishes

(available with an upcharge)

Honey Spice w/Mocha Highlight ▲

Natural w/Cocoa Highlight ▲

Premium Paint w/Glaze Finishes

(available with an upcharge)

Biscotti w/Coconut Glaze

Premium Stain w/Glaze Finishes

(available with an upcharge)

Rye w/Sable Glaze

Standard Stains

Cabernet

Chestnut

Honey Spice

Toffee

Natural

Kaffe

Cognac

Caramel

Cinnamon

Chocolate

Praline

Parchment

Rye

* Available on full overlay solid panel doors, except Mandolay

▲ Not available on Brookfield Birch

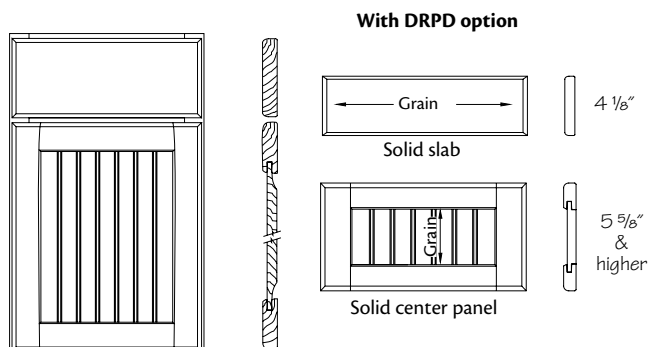

Brookfield Birch

BWB1

- Solid wood door frame with 2 1/4" stiles and rails
- Square solid beaded recessed panel on wall and base doors
- Grooves are 1 1/2" on center
- Slab drawer front
- Deluxe Recessed Beaded Panel Drawer Front available
- Full overlay door design
- Concealed hinge
- Decorative hardware is required

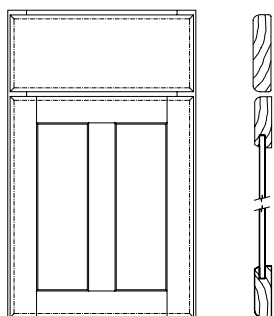

Dalton

HW1

- Solid wood door frame with 2 1/4" stiles and rails
- Single or multiple side by side veneer recessed panels on wall and base doors
- Glass door options have no center divider
- Slab drawer front
- Full overlay door design
- Concealed hinge
- Decorative hardware is required
- See Door Configuration Chart for panel arrangement

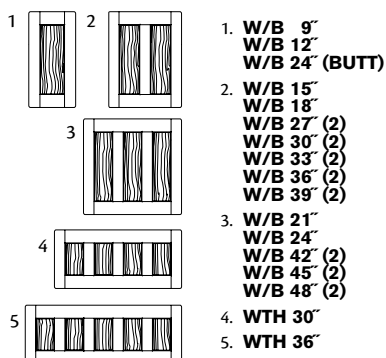

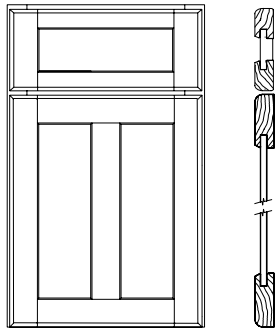

Door Configuration Chart



Fairport

NT1

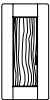
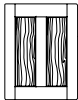
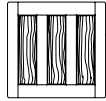
- Solid wood door frame with 2 1/4" stiles and rails
- Single or multiple side by side veneer recessed panels on wall and base doors
- Glass door options have no center divider
- Five-piece drawer front
- Full overlay door design
- Concealed hinge
- Decorative hardware is required
- See Door Configuration Chart for panel arrangement

<p>1 </p> <p>2 </p> <p>3 </p> <p>4 </p> <p>5 </p>	<p>1. W/B 9" W/B 12" W/B 24" (BUTT)</p> <p>2. W/B 15" W/B 18" W/B 27" (2) W/B 30" (2) W/B 33" (2) W/B 36" (2) W/B 39" (2)</p> <p>3. W/B 21" W/B 24" W/B 42" (2) W/B 45" (2) W/B 48" (2)</p> <p>4. WTH 30"</p> <p>5. WTH 36"</p>
--	--

Door Configuration Chart

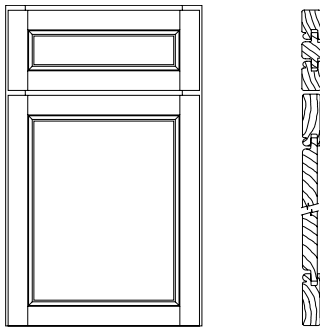

Mandolay Birch

PVB1

- Solid wood beaded door frame with 2 3/16" stiles and rails
- Square solid raised panel on wall and base doors
- Five-piece raised panel beaded drawer front
- Full overlay door design
- Concealed hinge
- Decorative hardware is required

Birch-Rustic

Natural Birch is a medium density hardwood with a fine, moderate grain pattern. The predominant sapwood color is white to creamy yellow, while the heartwood varies in color from medium or dark brown to reddish brown. The character of Rustic Birch may include some combination of open knots, wormholes and mineral streaks reflecting the inherent qualities in the natural beauty of wood.

Must order matching end panels for rustic finished ends.

Premium Antique Glaze Finishes

(available with an upcharge)

Antique Chocolate w/Mocha Glaze

Premium Burnished Finishes

(available with an upcharge)

Burnished Ginger

Burnished Praline

Burnished Cinnamon

Burnished Rye

Premium Stain w/Glaze Finishes

(available with an upcharge)

Cabernet w/Onyx Glaze

Chestnut w/Onyx Glaze

Cinnamon w/Onyx Glaze

Praline w/Onyx Glaze

Rye w/Onyx Glaze

Rye w/Sable Glaze

Standard Stains

Cinnamon

Chocolate

Chestnut

Cognac

Cabernet

Honey Spice

Kaffe

Natural

Praline

Toffee

Rye

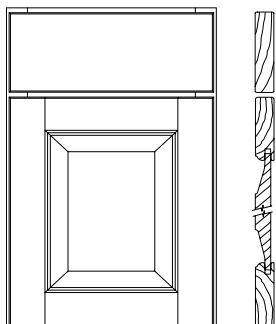

With DRPD option

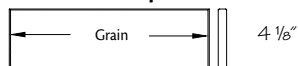

Solid Slab

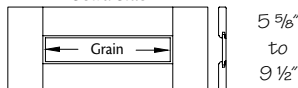

Veneer Center Panel

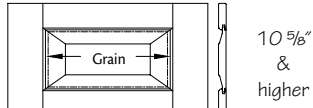

Solid Center Panel

Durango Birch

DAB1

- Solid wood door frame with 2 3/4" stiles and rails
- Square solid raised panel on wall and base doors
- This rustic door style features knotty or character birch wood. It contains character marks such as heartwood and mineral streaks of varying size.
- **Note:** Components of these doors are chosen at random, with the appearance of each individual door varying widely from very rustic to relatively clear and unmarked
- Slab drawer front
- Deluxe Raised Panel Drawer Front available
- Full overlay door design
- Concealed hinge
- Decorative hardware is required

Cherry

Cherry is an elegant, multi-colored hardwood, which may contain small knots and pinholes. Natural or light stains accent these color variations making a distinctive statement in a full kitchen. Cherry wood will darken or “mellow” with age. This mellowing is a natural occurrence and the benefit of owning a Cherry kitchen.

Premium Antique Glaze Finishes
(available with an upcharge)

Antique Chocolate w/Mocha Glaze ◆

Premium Burnished Finishes
(available with an upcharge)

Burnished Autumn Blush ※

Burnished Cabernet ※

Burnished Ginger ※

Burnished Chocolate ※

Burnished Rye ※

Burnished Cinnamon ※

Premium Highlight Finishes
(available with an upcharge)

Honey Spice w/Mocha Highlight ▲

Natural w/Cocoa Highlight ▲

Premium Stain w/Glaze Finishes
(available with an upcharge)

Autumn Blush w/Onyx Glaze †

Cabernet w/Onyx Glaze †

Chocolate w/Ebony Glaze †

Cinnamon w/Onyx Glaze †

Ginger w/Sable Glaze †

Rye w/Sable Glaze †

Rye w/Onyx Glaze †

Premium Vintage Finishes
(available with an upcharge)

Vintage Canvas ※

Vintage Dove White ※

Vintage Onyx ※

Vintage Biscotti ※

Vintage Willow ※

Vintage Cardinal ※

Vintage Sage ※

Vintage Mushroom ※

Premium Vintage Patina Finishes
(available with an upcharge)

Vintage Cardinal w/Onyx Patina ※

Vintage Sage w/Cocoa Patina ※

Vintage Sage w/Onyx Patina ※

Vintage Mushroom w/Cocoa Patina ※

Vintage Dove White w/Cocoa Patina ※

Vintage Canvas w/Cocoa Patina ※

Vintage Biscotti w/Cocoa Patina ※

Vintage Willow w/Cocoa Patina ※

Standard Stains

Autumn Blush

Cabernet

Honey Spice

Natural

Sunset

Kaffe

Cognac

Peppercorn

Cinnamon

Chocolate

Rye

- ◆ Not available on Saratoga and Fox Chase doors
- ※ Available on full overlay solid panel doors, except Mandolay
- ▲ Not available on Brookfield, Laurelwood and Saratoga
- † Not available on Saratoga

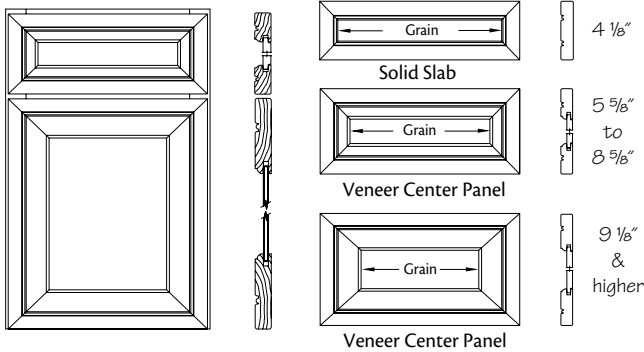

Argonne Cherry

ASCD1

- Solid wood mitered door frame with 3” stiles and rails
- Square veneer recessed panel on wall and base doors
- Drawer front varies depending on height
- Full overlay door design
- Concealed hinge
- Decorative hardware is required
- Optional Faux Hinge available; see Decorative Hardware section of this book

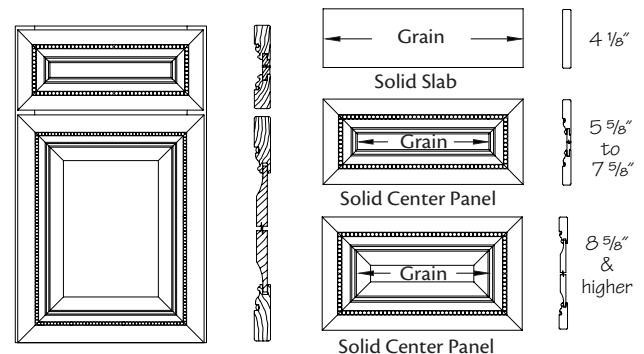

Astoria Cherry

ALC1

- Solid wood mitered door frame with 2 1/2” stiles and rails
- Square solid raised panel on wall and base doors
- Door frame features inset beaded molding
- Drawer front varies depending on height
- Full overlay door design
- Concealed hinge
- Decorative hardware is required

Bradford

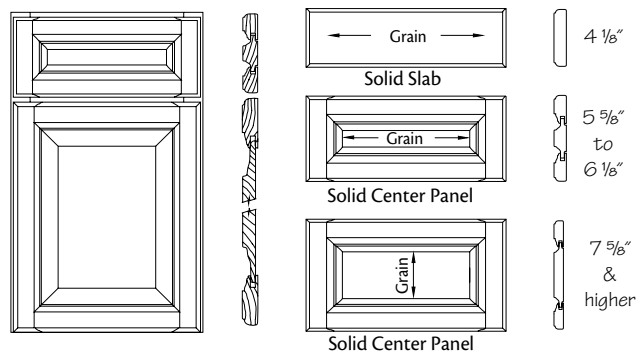

BF1

- Solid wood door frame with 2 3/16" stiles and rails
- Square solid raised panel on wall and base doors
- Drawer front varies depending on height
- Full overlay door design
- Concealed hinge
- Decorative hardware is required

Brookfield Cherry

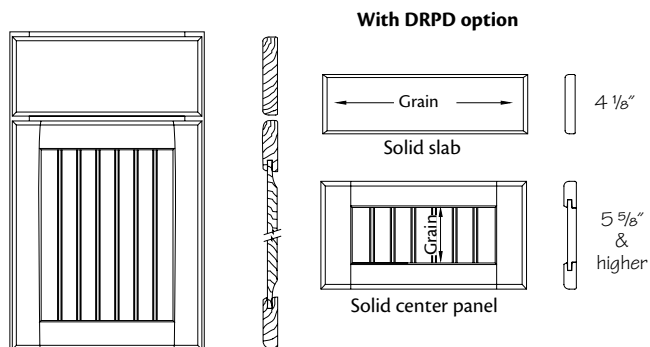

With DRPD option

BWC1

- Solid wood door frame with 2 1/4" stiles and rails
- Square solid beaded recessed panel on wall and base doors
- Grooves are 1 1/2" on center
- Slab drawer front
- Deluxe Recessed Beaded Panel Drawer Front available
- Full overlay door design
- Concealed hinge
- Decorative hardware is required

Chadwick Cherry

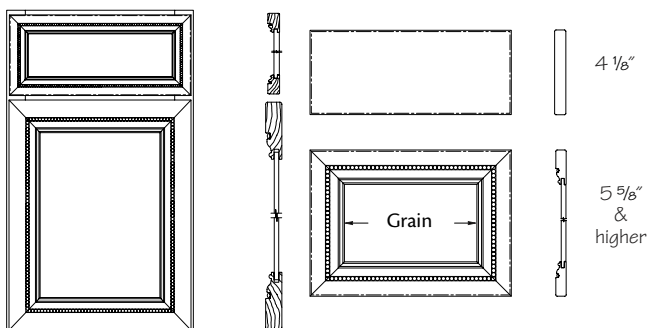

CTC1

- Solid wood mitered door frame with 2 1/2" stiles and rails
- Square veneer recessed panel on wall and base doors
- Door frame features inset beaded molding
- Drawer front varies depending on height
- Full overlay door design
- Concealed hinge
- Decorative hardware is required

Courtney Cherry

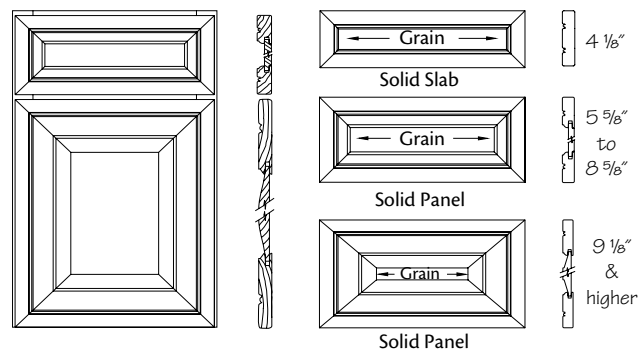

CRC1

- Solid wood mitered door frame with 3" stiles and rails
- Square solid raised panel on wall and base doors
- Drawer front varies depending on height
- Full overlay door design
- Concealed hinge
- Decorative hardware is required
- Optional Faux Hinge available; see Decorative Hardware section of this book

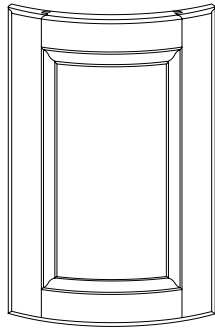

Curved Cherry

- Available in Bradford and all Marquette Cherry (half & full)
- **Not** available in Argonne, Astoria, Brockton, Brookfield, Chadwick, Courtney, Dresden Cherry, Eldridge, all Fox Chase, Garrison, Grandview, Grandview Cathedral, Greenwich, Halstead, Harlowe, Harrington, Jamison, Judson, Kendrick, Knollwood, Lasalle, Lincoln, Lindsay, Lockeford, Lyndale, Mandolay, North Hampton, Northwicke, Parker House, Patterson, Putnam, Richland, Rutherford, Saratoga, Sedona, Seton, Smithton, Tennyson or Vanderbilt

Dresden Cherry

DRC1

- Solid wood mitered door frame with 2 1/2" stiles and rails
- Square veneer recessed panel on wall and base doors
- Doors feature inset rope molding surrounding center panel
- Five-piece recessed panel drawer front with inset rope molding
- Full overlay door design
- Concealed hinge
- Decorative hardware is required

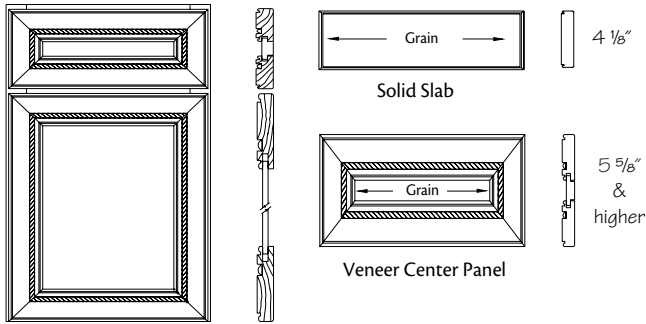

Eldridge Cherry Square

AA2C1

- Color coding indicates new product, size or code*
- Solid wood mitered door frame with 3" stiles and rails
 - Square veneer recessed panel on wall and base doors
 - Drawer front varies depending on height
 - Full overlay door design
 - Concealed hinge
 - Decorative hardware is required

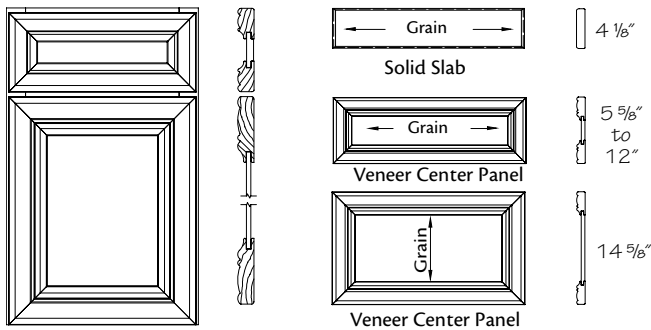

Fox Chase Cherry Roman-Half

AB8C1

- Color coding indicates new product, size or code*
- Solid wood door frame with 2 3/16" stiles and rails
 - Roman arched veneer raised panel wall doors
 - Square veneer raised panel base doors
 - Slab drawer front
 - 1/2" overlay door design
 - Concealed or optional knife hinge
 - Finger Pull Rout (FPR) is available
 - Decorative hardware is **not** required

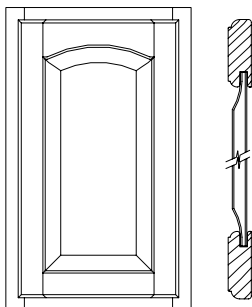

New

New

New

Fox Chase Cherry Square-Half

AB7C1

Color coding indicates new product, size or code

- Solid wood door frame with 2 3/16" stiles and rails
- Square veneer raised panel on wall and base doors
- Slab drawer front
- 1/2" overlay door design
- Concealed or optional knife hinge
- Finger Pull Rout (FPR) is available
- Decorative hardware is **not** required

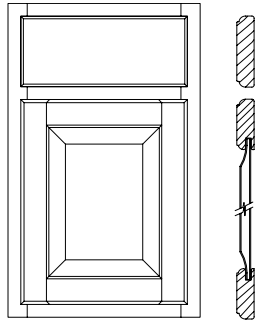

New

Fox Chase Cherry Roman-Full

AC0C1

Color coding indicates new product, size or code

- Solid wood door frame with 2 3/16" stiles and rails
- Roman arched veneer raised panel wall doors
- Square veneer raised panel base doors
- Slab drawer front
- Full overlay door design
- Concealed hinge
- Decorative hardware is required

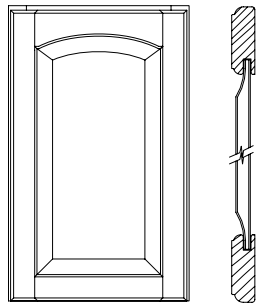

New

Fox Chase Cherry Square-Full

AB9C1

Color coding indicates new product, size or code

- Solid wood door frame with 2 3/16" stiles and rails
- Square veneer raised panel on wall and base doors
- Slab drawer front
- Full overlay door design
- Concealed hinge
- Decorative hardware is required

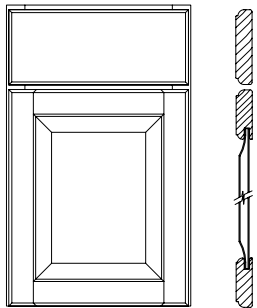

New

Garrison Cherry Square

AB1C1

Color coding indicates new product, size or code

- Solid wood mitered door frame with 3" stiles and rails
- Square solid raised panel on wall and base doors
- Slab drawer front
- Deluxe Raised Panel Drawer Front available
- Full overlay door design
- Concealed hinge
- Decorative hardware is required

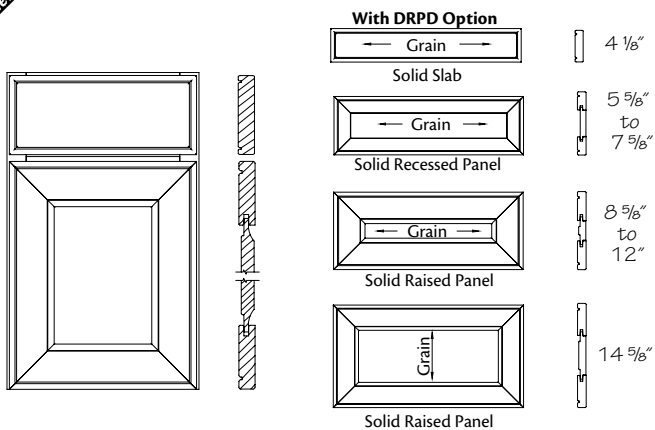

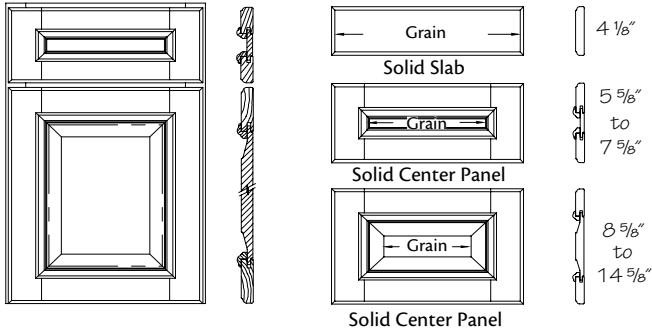

Glennberry Cherry Square

GRC1

- Solid wood door frame with 2 1/2" stiles and rails
- Square solid raised panel on wall and base doors
- Applied decorative molding
- Drawer front varies depending on height
- Full overlay door design
- Concealed hinge
- Decorative hardware is required

Grandview

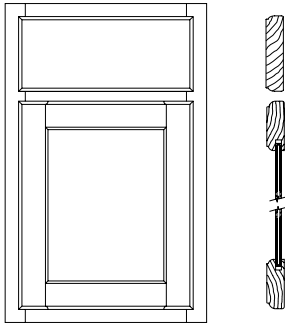

2GCS1

- Solid wood door frame with 2 3/16" stiles and rails
- Square veneer recessed panel on wall and base doors
- Slab drawer front
- 1/2" overlay door design
- Concealed or optional knife hinge
- Finger Pull Rout (FPR) is available
- Decorative hardware is **not** required

Grandview Cathedral

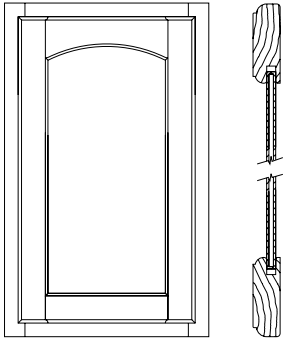

2GCR1

- Solid wood door frame with 2 3/16" stiles and rails
- Roman arched veneer recessed panel wall doors
- Square veneer recessed panel base doors
- Slab drawer front
- 1/2" overlay door design
- Concealed or optional knife hinge
- Finger Pull Rout (FPR) is available
- Decorative hardware is **not** required

Halstead Cherry

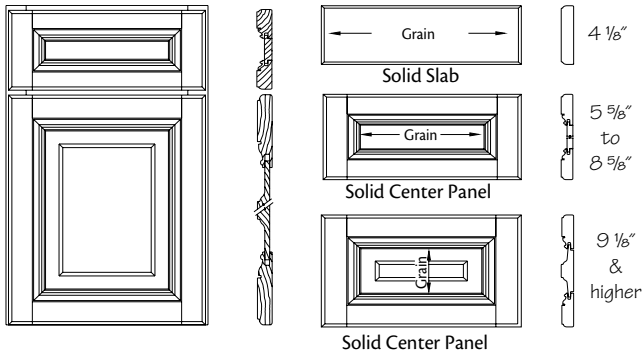

HLC1

- Solid wood door frame with 2 3/4" stiles and rails
- Door frame features "picture frame" style inset molding
- Square solid raised panel on wall and base doors
- Drawer front varies depending on height
- Full overlay door design
- Concealed hinge
- Decorative hardware is required

New

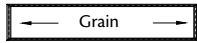
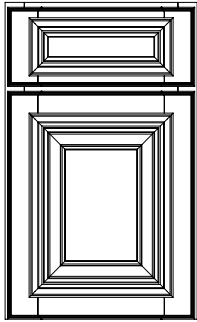

Solid Slab

4 1/8"

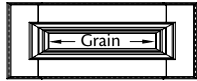

Solid Recessed Panel

5 5/8"
to
9 7/8"

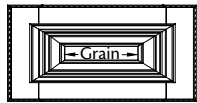

Solid Raised Panel

10 5/8"
to
12"

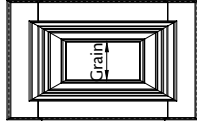

Solid Raised Panel

14 5/8"

Harlowe Cherry Square

AA3C1

Color coding indicates new product, size or code

- Solid wood door frame with 2 5/8" stiles and rails
- Square solid raised panel on wall and base doors
- Applied decorative molding
- Drawer front varies depending on height
- Full overlay door design
- Concealed hinge
- Decorative hardware is required

New

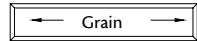
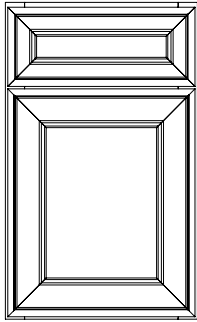

Solid Slab

4 1/8"

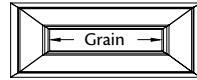

Veneer Center Panel

5 5/8"
to
12"

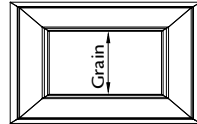

Veneer Center Panel

14 5/8"

Harrington Cherry Square

AA6C1

Color coding indicates new product, size or code

- Solid wood mitered door frame with 3" stiles and rails
- Square veneer recessed panel on wall and base doors
- Drawer front varies depending on height
- Full overlay door design
- Concealed hinge
- Decorative hardware is required

New

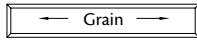
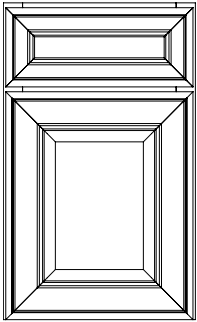

Solid Slab

4 1/8"

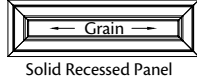

Solid Recessed Panel

5 5/8"
to
7 5/8"

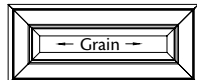

Solid Raised Panel

8 5/8"
to
12"

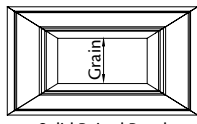

Solid Raised Panel

14 5/8"

Jamison Cherry Square

AA5C1

Color coding indicates new product, size or code

- Solid wood door frame with 3" stiles and rails
- Square solid raised panel on wall and base doors
- Drawer front varies depending on height
- Full overlay door design
- Concealed hinge
- Decorative hardware is required

New

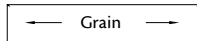
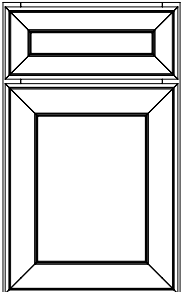

Solid Slab

4 1/8"



Veneer Center Panel

5 5/8"
to
6 1/8"

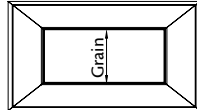

Veneer Center Panel

7 5/8"
and
higher

Judson Cherry Square

AB5C1

Color coding indicates new product, size or code

- Solid wood mitered door frame with 2 3/4" stiles and rails
- Square veneer recessed panel on wall and base doors
- Drawer front varies depending on height
- Wood grain orientation on drawer fronts is vertical, unless noted
- Full overlay door design
- Concealed hinge
- Decorative hardware is required

New

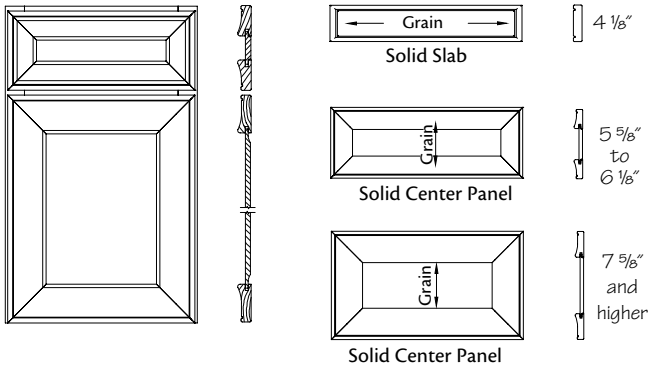

Kendrick Cherry Square

AB6C1

Color coding indicates new product, size or code

- Solid wood mitered door frame with 3" stiles and rails
- Square solid recessed panel on wall and base doors
- Drawer front varies depending on height
- Wood grain orientation on drawer fronts is vertical, unless noted
- Full overlay door design
- Concealed hinge
- Decorative hardware is required

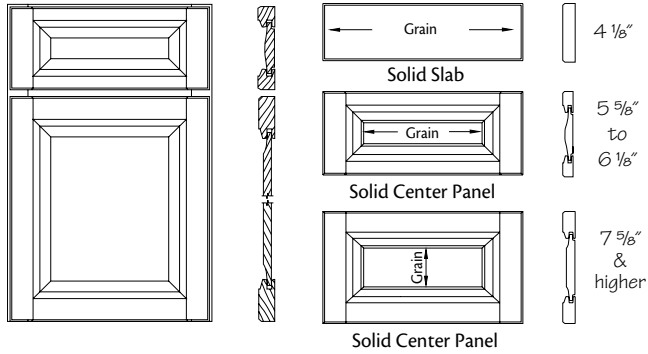

Knollwood Cherry Square

PKC1

- Solid wood door frame with 2 3/16" stiles and rails
- Square solid raised panel on wall and base doors
- Drawer front varies depending on height
- Full overlay door design
- Concealed hinge
- Decorative hardware is required

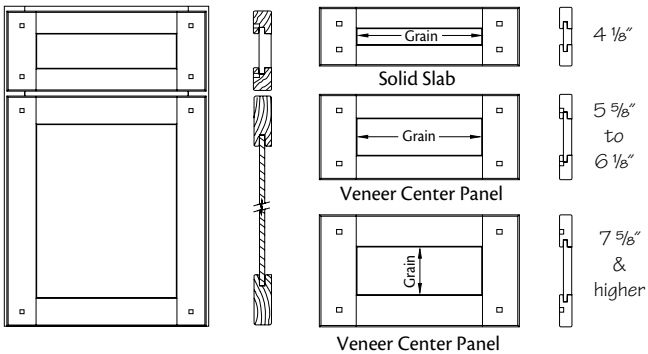

Lasalle

LBD1

- Solid wood door frame with walnut pegs in 2 3/16" stiles and rails
- Square veneer recessed panel on wall and base doors
- Five-piece recessed drawer front with walnut pegs
- When drawer fronts are supplied as a solid slab, they will **not** have corner pegs
- Full overlay door design
- Concealed hinge
- Decorative hardware is required

New

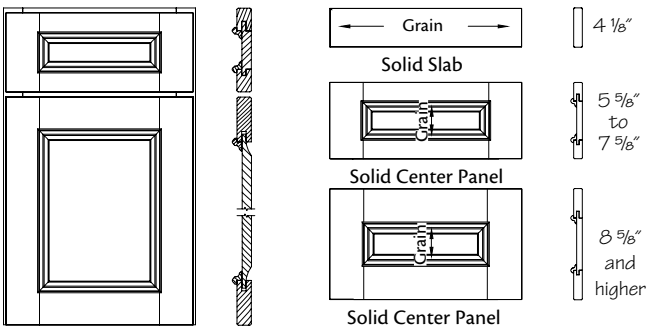

Lincoln Cherry Square

AB3C1

Color coding indicates new product, size or code

- Solid wood door frame with 2 5/8" stiles and rails
- Square solid recessed panel on wall and base doors
- Drawer front varies depending on height
- Wood grain orientation on drawer fronts is vertical, unless noted
- Full overlay door design
- Concealed hinge
- Decorative hardware is required

Lindsay Cherry

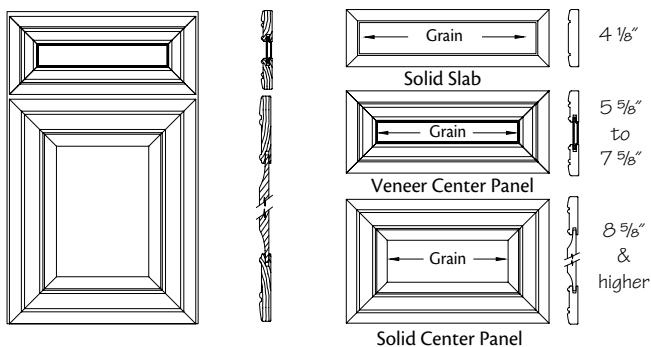

BLC1

- Solid wood mitered door frame with 2 3/4" stiles and rails
- Square solid raised panel on wall and base doors
- Drawer front varies depending on height
- Full overlay door design
- Concealed hinge
- Decorative hardware is required

Lockeford Cherry

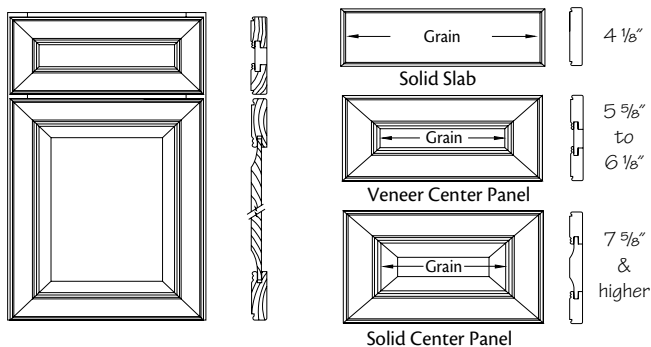

LCC1

- Solid wood mitered beaded door frame with 2 3/16" stiles and rails
- Square solid raised panel on wall and base doors
- Drawer front varies depending on height
- Full overlay door design
- Concealed hinge
- Decorative hardware is required

Lyndale

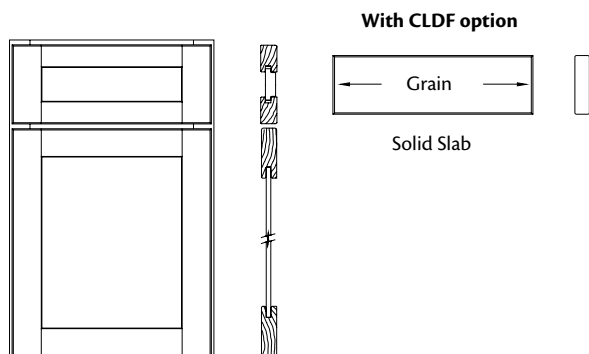

LY1

- Solid wood door frame with 2 3/16" stiles and rails
- Square veneer recessed panel on wall and base doors
- Five-piece drawer front
- Classic Drawer Front option available
- Full overlay door design
- Concealed hinge
- Decorative hardware is required

Mandolay Cherry

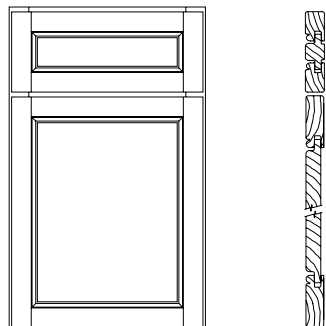

PVC1

- Solid wood beaded door frame with 2 3/16" stiles and rails
- Square solid raised panel on wall and base doors
- Five-piece raised panel beaded drawer front
- Full overlay door design
- Concealed hinge
- Decorative hardware is required

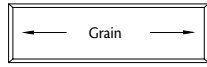
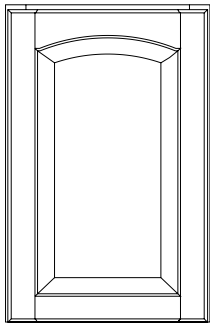

4 1/8"

Solid Slab

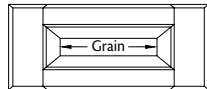

5 5/8"
to
6 1/8"

Solid Center Panel

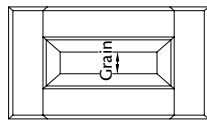

7 5/8"
&
higher

Solid Center Panel

Marquette Cherry Roman-Full

PWC1

- Solid wood door frame with 2 3/16" stiles and rails
- Roman arched solid raised panel wall doors
- Square solid raised panel base doors
- Drawer front varies depending on height
- Classic Drawer Front option available
- Full overlay door design
- Concealed hinge
- Decorative hardware is required

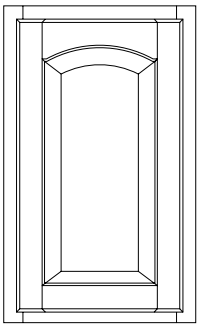

3 1/2"

Solid Slab

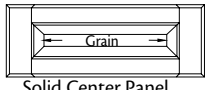

4 1/4"
to
7"

Solid Center Panel

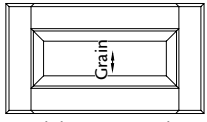

8 3/4"
&
higher

Solid Center Panel

Marquette Cherry Roman-Half

TWAC1

- Solid wood door frame with 2 3/16" stiles and rails
- Roman arched solid raised panel wall doors
- Square solid raised panel base doors
- Drawer front varies depending on height
- Classic Drawer Front option available
- 1/2" overlay door design
- Concealed hinge
- Decorative hardware is required

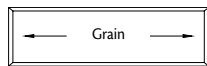
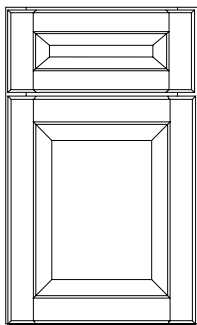

4 1/8"

Solid Slab

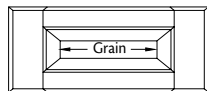

5 5/8"
to
6 1/8"

Solid Center Panel

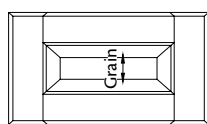

7 5/8"
&
higher

Solid Center Panel

Marquette Cherry Square-Full

MTC1

- Solid wood door frame with 2 3/16" stiles and rails
- Square solid raised panel on wall and base doors
- Drawer front varies depending on height
- Classic Drawer Front option available
- Full overlay door design
- Concealed hinge
- Decorative hardware is required

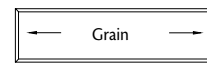
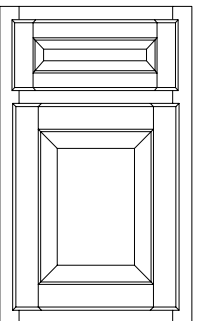

3 1/2"

Solid Slab

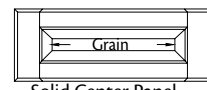

4 1/4"
to
7"

Solid Center Panel

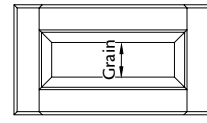

8 3/4"
&
higher

Solid Center Panel

Marquette Cherry Square-Half

TWSC1

- Solid wood door frame with 2 3/16" stiles and rails
- Square solid raised panel on wall and base doors
- Drawer front varies depending on height
- Classic Drawer Front option available
- 1/2" overlay door design
- Concealed hinge
- Decorative hardware is required

New

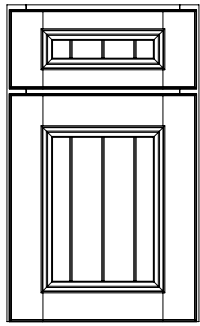

Solid Slab

4 1/8"



Solid Center Panel

5 5/8"
to
7 5/8"

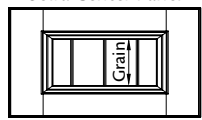

Solid Center Panel

8 5/8"
and
higher

North Hampton Cherry Square

AA9C1

Color coding indicates new product, size or code

- Solid wood door frame with 3" stiles and rails
- Square solid v-grooved recessed panel on wall and base doors
- Grooves are 2 1/2" on center
- Applied decorative molding
- Wood grain orientation on drawer fronts is vertical, unless noted
- Drawer front varies depending on height
- Full overlay door design
- Concealed hinge
- Decorative hardware is required

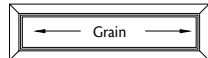
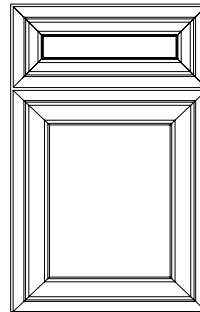

Solid Slab

4 1/8"

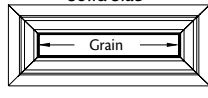

Veneer Center Panel

5 5/8"
to
7 5/8"

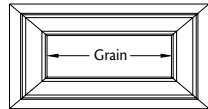

Veneer Center Panel

8 5/8"
&
higher

Northwicke Cherry

NBC1

- Solid wood mitered door frame with 2 3/4" stiles and rails
- Square veneer recessed panel on wall and base doors
- Drawer front varies depending on height
- Full overlay door design
- Concealed hinge
- Decorative hardware is required

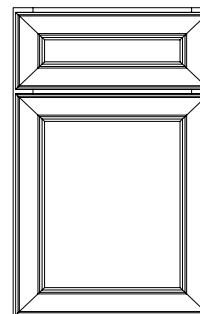

Solid Slab

4 1/8"

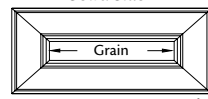

Veneer Center Panel

5 5/8"
to
6 1/2"

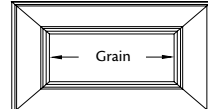

Veneer Center Panel

7 5/8"
&
higher

Parker House Cherry

PDC1

- Solid wood mitered beaded door frame with 2 3/16" stiles and rails
- Square veneer recessed panel on wall and base doors
- Drawer front varies depending on height
- Full overlay door design
- Concealed hinge
- Decorative hardware is required

New

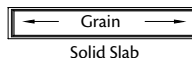
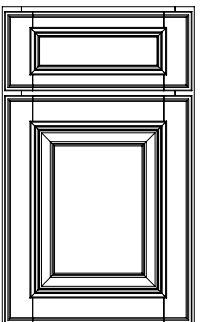

Solid Slab

4 1/8"

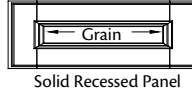

Solid Recessed Panel

5 5/8"
to
8 5/8"

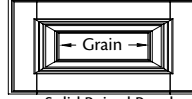

Solid Raised Panel

9 1/8"
to
12"

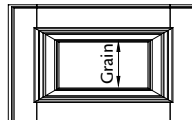

Solid Raised Panel

14 5/8"

Patterson Cherry Square

AA4C1

Color coding indicates new product, size or code

- Solid wood door frame with 2 3/16" stiles and rails
- Square solid raised panel on wall and base doors
- Applied decorative molding
- Drawer front varies depending on height
- Full overlay door design
- Concealed hinge
- Decorative hardware is required

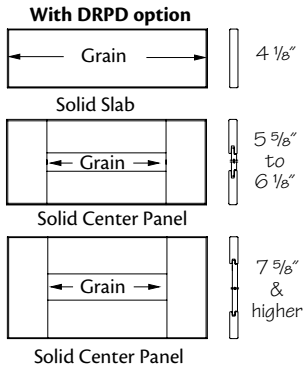
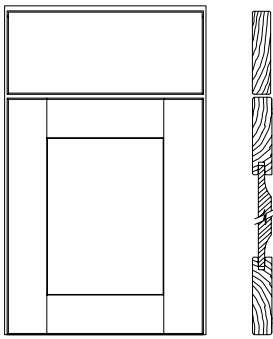

Putnam Cherry

DRHC1

- Solid wood door frame with 3" stiles and rails
- Square solid recessed panel on wall and base doors
- Slab drawer front
- Deluxe Recessed Panel Drawer Front available
- Full overlay door design
- Concealed hinge
- Decorative hardware is required

New

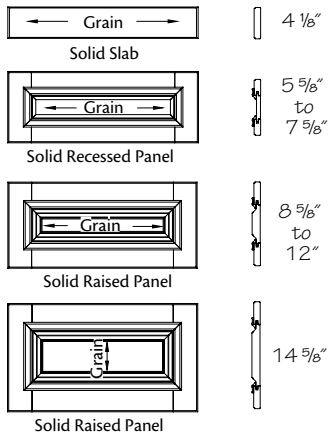
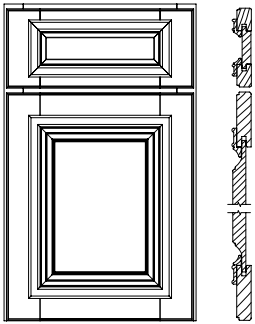

Richland Cherry Square

AA7C1

- Color coding indicates new product, size or code*
- Solid wood door frame with 2 5/8" stiles and rails
 - Square solid raised panel on wall and base doors
 - Applied decorative molding
 - Drawer front varies depending on height
 - Full overlay door design
 - Concealed hinge
 - Decorative hardware is required

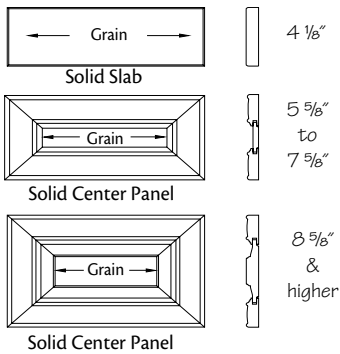
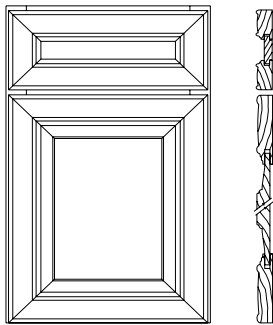

Rutherford Cherry

RTC1

- Solid wood mitered door frame with 2 3/8" stiles and rails
- Square solid raised panel on wall and base doors
- Drawer front varies depending on height
- Full overlay door design
- Concealed hinge
- Decorative hardware is required

Saratoga

AW1

- Solid slab on wall and base doors
- Slab drawer front
- Full overlay door design
- Concealed hinge
- Decorative hardware is required

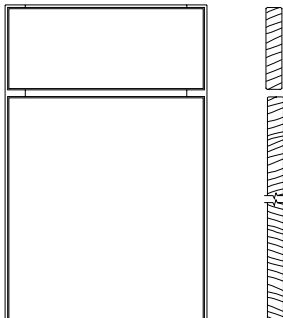

Sedona Cherry

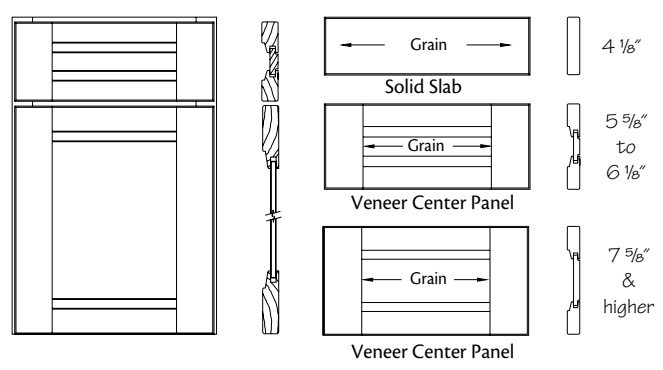

SNC1

- Solid wood door frame with 2 3/4" stiles and rails
- Square veneer recessed panel on wall and base doors
- Drawer front varies depending on height
- Classic Drawer Front option available
- Full overlay door design
- Concealed hinge
- Decorative hardware is required

New

Seton Cherry Square

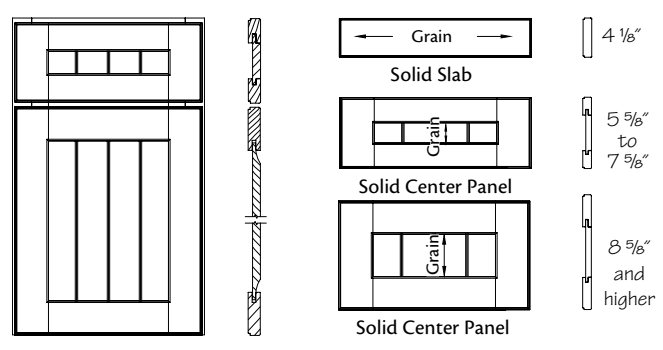

AB0C1

- Color coding indicates new product, size or code*
- Solid wood door frame with 2 5/8" stiles and rails
 - Square solid v-grooved recessed panel on wall and base doors
 - Grooves are 2 1/2" on center
 - Wood grain orientation on drawer fronts is vertical, unless noted
 - Drawer front varies depending on height
 - Full overlay door design
 - Concealed hinge
 - Decorative hardware is required

New

Smithton Cherry Square

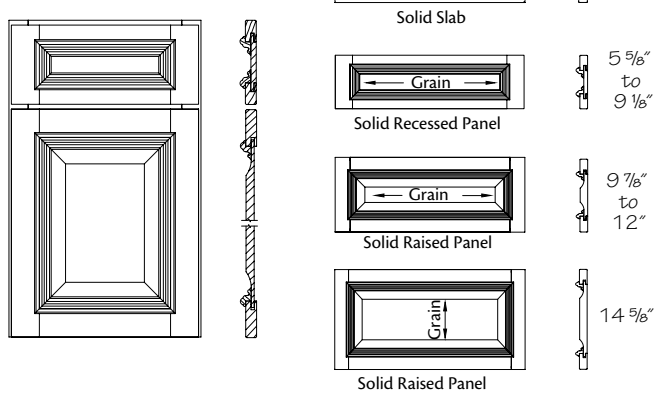

AA8C1

- Color coding indicates new product, size or code*
- Solid wood door frame with 2 3/16" stiles and rails
 - Square solid raised panel on wall and base doors
 - Applied decorative molding
 - Drawer front varies depending on height
 - Full overlay door design
 - Concealed hinge
 - Decorative hardware is required

New

Tennyson Cherry Square

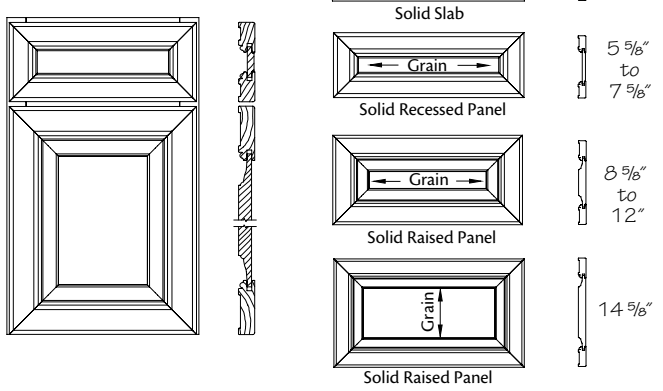

AA0C1

- Color coding indicates new product, size or code*
- Solid wood mitered door frame with 2 5/8" stiles and rails
 - Square solid raised panel on wall and base doors
 - Drawer front varies depending on height
 - Full overlay door design
 - Concealed hinge
 - Decorative hardware is required

New

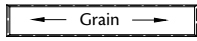
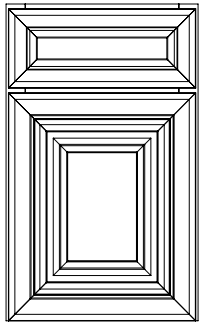

Solid Slab

4 1/8"

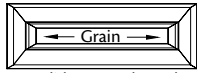

Solid Recessed Panel

5 5/8"
to
9 1/2"

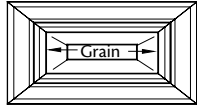

Solid Raised Panel

10 5/8"
to
12"

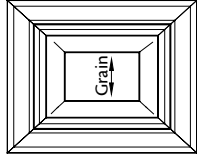

Solid Raised Panel

14 5/8"

Vanderbilt Cherry Square

AA1C1

Color coding indicates new product, size or code

- Solid wood mitered door frame with 3" stiles and rails
- Square solid raised panel on wall and base doors
- Drawer front varies depending on height
- Full overlay door design
- Concealed hinge
- Decorative hardware is required

Cherry-Quartersawn

Cherry is an elegant, multicolored hardwood, which may contain small knots and pinholes. Natural or light stains accent these color variations making a distinctive statement in a full kitchen. Cherry wood will darken or “mellow” with age. This mellowing is a natural occurrence and the benefit of owning a Cherry kitchen.

Quartersawn refers to the method of cutting the Cherry. Boards are cut through the radius of the rings allowing wavy grain and flaked patterns to show on the face.

Standard Stains

Autumn Blush
Cinnamon
Cabernet
Honey Spice
Kaffe
Natural
Peppercorn
Chocolate
Rye

New

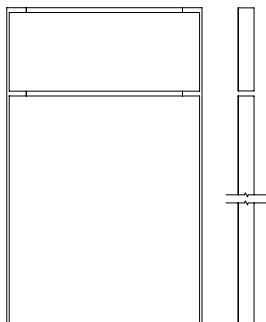

Brockton Cherry Square

AB4C1

Color coding indicates new product, size or code

- Quartersawn veneer slab on wall and base doors
- Quartersawn veneer slab drawer fronts
- Wood grain orientation on drawer fronts is vertical, unless noted
- Full overlay door design
- Concealed hinge
- Decorative hardware is required

Cherry-Rustic

Cherry is an elegant, multicolored hardwood, which may contain small knots and pinholes. Natural or light stains accent these color variations making a distinctive statement in a full kitchen. Cherry wood will darken or “mellow” with age. This mellowing is a natural occurrence and the benefit of owning a Cherry kitchen. The character of Rustic Cherry may include some combination of open knots, wormholes and mineral streaks reflecting the inherent qualities in the natural beauty of wood.

Must order matching end panels for rustic finished ends.

Premium Antique Glaze Finishes *(available with an upcharge)*

Antique Chocolate w/Mocha Glaze

Premium Burnished Finishes *(available with an upcharge)*

Burnished Autumn Blush

Burnished Ginger

Burnished Chocolate

Burnished Cabernet

Burnished Rye

Burnished Cinnamon

Premium Highlight Finishes *(available with an upcharge)*

Natural w/Cocoa Highlight

Honey Spice w/Mocha Highlight

Premium Stain w/Glaze Finishes *(available with an upcharge)*

Chocolate w/Ebony Glaze

Ginger w/Sable Glaze

Rye w/Sable Glaze

Rye w/Onyx Glaze

Cinnamon w/Onyx Glaze

Autumn Blush w/Onyx Glaze

Cabernet w/Onyx Glaze

Premium Vintage Finishes *(available with an upcharge)*

Vintage Canvas

Vintage Dove White

Vintage Onyx

Vintage Biscotti

Vintage Willow

Vintage Cardinal

Vintage Sage

Vintage Mushroom

Premium Vintage Patina Finishes *(available with an upcharge)*

Vintage Cardinal w/Onyx Patina

Vintage Sage w/Cocoa Patina

Vintage Sage w/Onyx Patina

Vintage Mushroom w/Cocoa Patina

Vintage Dove White w/Cocoa Patina

Vintage Canvas w/Cocoa Patina

Vintage Biscotti w/Cocoa Patina

Vintage Willow w/Cocoa Patina

Standard Stains

Autumn Blush

Cinnamon

Chocolate

Cognac

Cabernet

Honey Spice

Kaffe

Natural

Peppercorn

Sunset

Rye

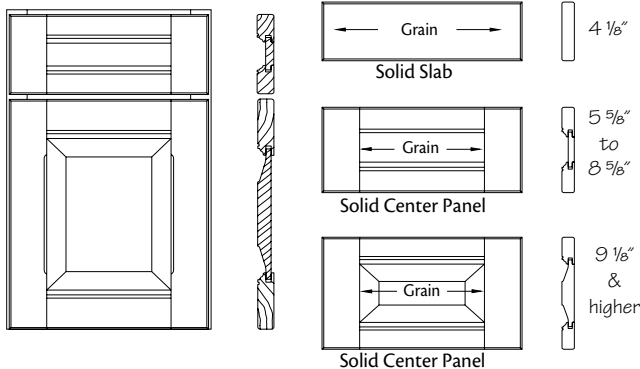

Greenwich

LWB1

- Solid wood door frame with 2 3/4" stiles and 3" rails
- Square solid raised panel on wall and base doors
- This door style features knotty or character Cherry wood. It contains character marks such as heartwood, worm holes and mineral streaks of varying size.
- **Note:** Components of these doors are chosen at random, with the appearance of each individual door varying widely from very rustic to relatively clear and unmarked
- Drawer front varies depending on height
- Full overlay door design
- Concealed hinge
- Decorative hardware is required

Hickory

Hickory is a strong, open-grained wood that is known for its wide variation in color. It is not uncommon to see doors or parts of doors that range in color from light to a deep brown when finished in light or natural stains. Darker stains will mildly tone these color variations. These characteristics are what makes each Hickory kitchen unique and the preference of those that love wood.

Premium Burnished Finishes

(available with an upcharge)

Burnished Praline †

Premium Highlight Finishes

(available with an upcharge)

Honey Spice w/Mocha Highlight ▲

Natural w/Cocoa Highlight ▲

Premium Stain w/Glaze Finishes

(available with an upcharge)

Rye w/Onyx Glaze

Rye w/Sable Glaze

Praline w/Onyx Glaze

Standard Stains

Honey Spice

Natural

Sunset

Kaffe

Cognac

Praline

Rye

† Available on full overlay solid panel doors

▲ Not available on Brookfield Hickory

Abington Hickory

TMKH1

- Solid wood door frame with walnut pegs in 2 1/4" stiles and rails
- Single or multiple side by side veneer recessed panels on wall and base doors
- Glass door options have no center divider
- Five-piece recessed drawer front with walnut pegs
- When drawer fronts are supplied as a solid slab, they will **not** have corner pegs
- Full overlay door design
- Concealed hinge
- Decorative hardware is required
- See Door Configuration Chart for panel arrangement

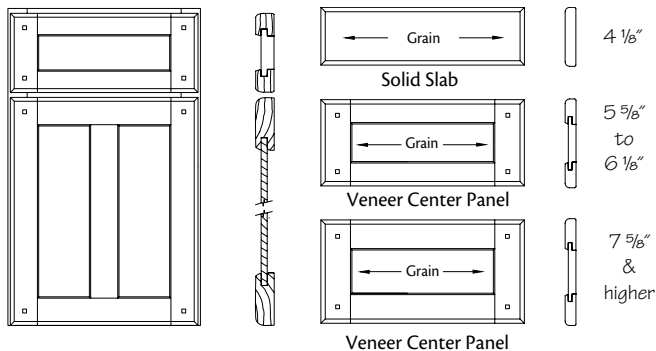

Door Configuration Chart

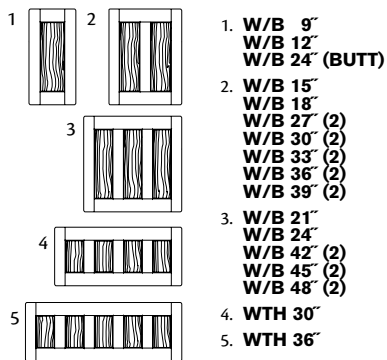

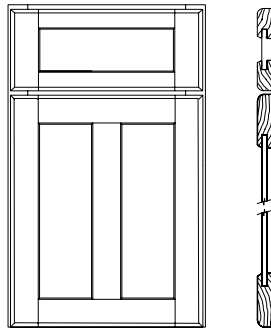

Bedford

TY1

- Solid wood door frame with 2 1/4" stiles and rails
- Single or multiple side by side veneer recessed panels on wall and base doors
- Glass door options have no center divider
- Five-piece drawer front
- Full overlay door design
- Concealed hinge
- Decorative hardware is required
- See Door Configuration Chart for panel arrangement

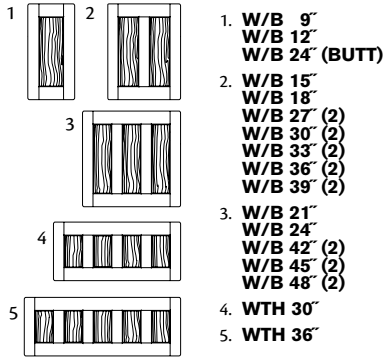

Door Configuration Chart

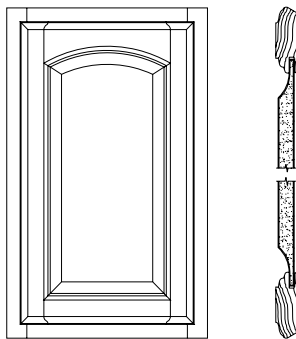

Berkeley

2WX1

- Solid wood door frame with 2 3/16" stiles and rails
- Roman arched veneer raised panel wall doors
- Base doors same design as Westwood (2WT1)
- Reverse bevel lip
- Slab drawer front
- 1/2" overlay door design
- Concealed or optional knife hinge
- Decorative hardware is **not** required

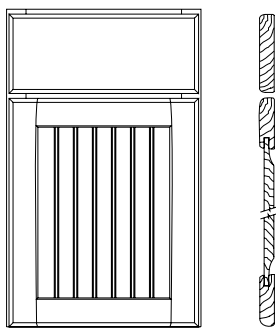

With DRPD option

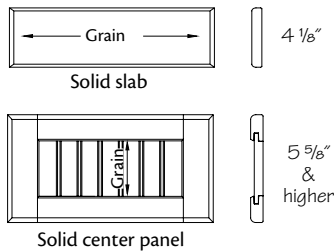

Brookfield Hickory

BWH1

- Solid wood door frame with 2 1/4" stiles and rails
- Square solid beaded recessed panel on wall and base doors
- Grooves are 1 1/2" on center
- Slab drawer front
- Deluxe Recessed Beaded Panel Drawer Front available
- Full overlay door design
- Concealed hinge
- Decorative hardware is required

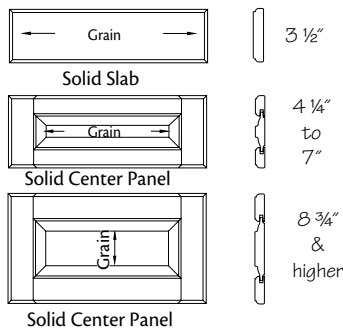
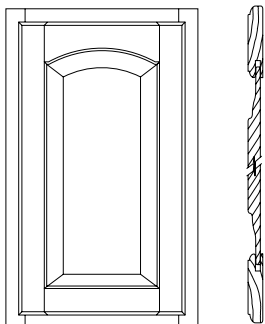

Marquette Hickory Roman-Half

TWAH1

- Solid wood door frame with 2 3/16" stiles and rails
- Roman arched solid raised panel wall doors
- Square solid raised panel base doors
- Drawer front varies depending on height
- Classic Drawer Front option available
- 1/2" overlay door design
- Concealed hinge
- Decorative hardware is required

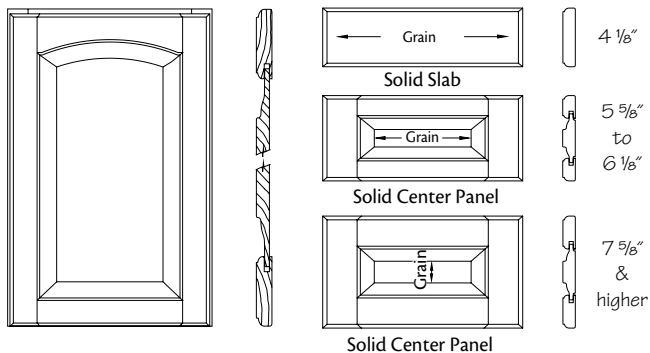

Marquette Hickory Roman-Full

PWH1

- Solid wood door frame with 2 3/16" stiles and rails
- Roman arched solid raised panel wall doors
- Square solid raised panel base doors
- Drawer front varies depending on height
- Classic Drawer Front option available
- Full overlay door design
- Concealed hinge
- Decorative hardware is required

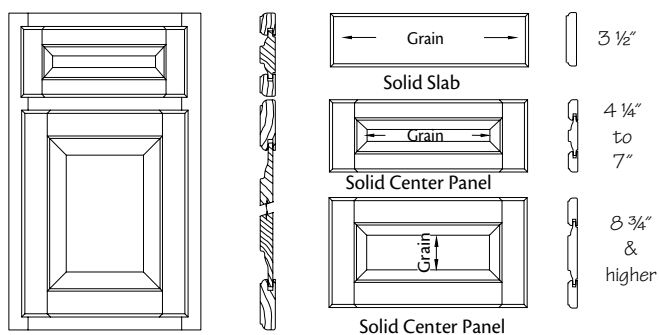

Marquette Hickory Square-Half

TWSH1

- Solid wood door frame with 2 3/16" stiles and rails
- Square solid raised panel on wall and base doors
- Drawer front varies depending on height
- Classic Drawer Front option available
- 1/2" overlay door design
- Concealed hinge
- Decorative hardware is required

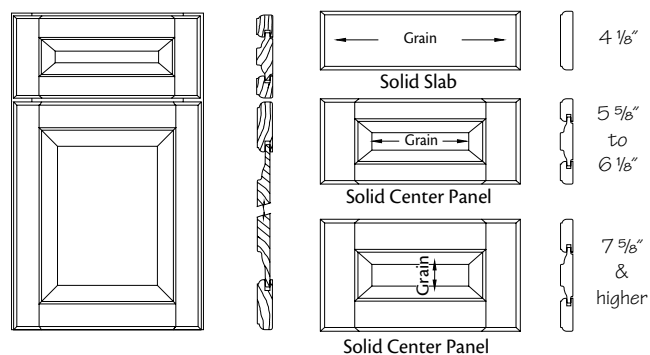

Marquette Hickory Square-Full

MTH1

- Solid wood door frame with 2 3/16" stiles and rails
- Square solid raised panel on wall and base doors
- Drawer front varies depending on height
- Classic Drawer Front option available
- Full overlay door design
- Concealed hinge
- Decorative hardware is required

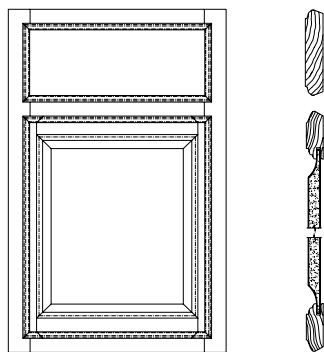

Westwood

2WT1

- Solid wood door frame with 2 3/16" stiles and rails
- Square veneer raised panel on wall and base doors
- Reverse bevel lip
- Slab drawer front
- 1/2" overlay door design
- Concealed or optional knife hinge
- Decorative hardware is **not** required

Hickory-Rustic

Hickory is a strong, open-grained wood that is known for its wide variation in color. It is not uncommon to see doors or parts of doors that range in color from light to a deep brown when finished in light or natural stains. Darker stains will mildly tone these color variations. These characteristics are what make each Hickory kitchen unique and the preference of those that love wood. The character of Rustic Hickory may include some combination of open knots, wormholes and mineral streaks reflecting the inherent qualities in the natural beauty of wood.

Must order matching end panels for rustic finished ends.

Premium Burnished Finishes
(available with an upcharge)

Burnished Praline

Premium Highlight Finishes
(available with an upcharge)

Natural w/Cocoa Highlight
Honey Spice w/Mocha Highlight

Premium Stain w/Glaze Finishes
(available with an upcharge)

Praline w/Onyx Glaze
Rye w/Onyx Glaze
Rye w/Sable Glaze

Standard Stains

Honey Spice
Natural
Sunset
Kaffe
Cognac
Praline
Rye

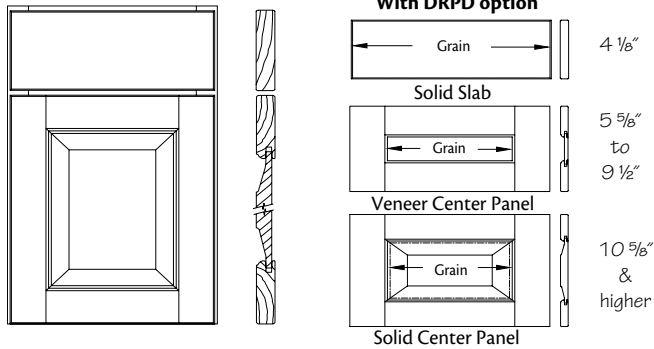

Durango Hickory

DAH1

- Solid wood door frame with 2 3/4" stiles and rails
- Square solid raised panel on wall and base doors
- This door style features knotty or character hickory wood. It contains character marks such as heartwood and mineral streaks of varying size.
- **Note:** Components of these doors are chosen at random, with the appearance of each individual door varying widely from very rustic to relatively clear and unmarked
- Slab drawer front
- Deluxe Raised Panel Drawer Front available
- Full overlay door design
- Concealed hinge
- Decorative hardware is required

Laminate

This Laminate cabinetry features solid hardwood face frames with a Durakraft furniture finish. Doors, drawer heads and exposed exterior surfaces are clad with durable laminate. While great care has been taken to match the Durakraft finish to the laminate, texture and color variations can be expected throughout this Laminate cabinetry.

Standard Laminate Finishes
White
Cream

Note: Based on independent testing, discoloration will occur to White doors and cabinet parts after prolonged exposure to tobacco smoke.

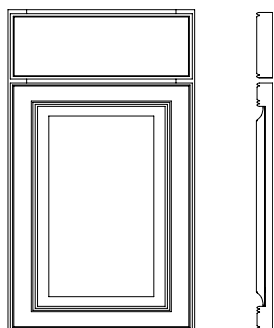

Ashfield Cream

ACS1

- Thermofoil on 3/4" thick MDF substrate
- Square raised center panel on wall and base doors
- Beaded frame profile
- Slab drawer front
- Full overlay door design
- Concealed hinge
- Decorative hardware is required

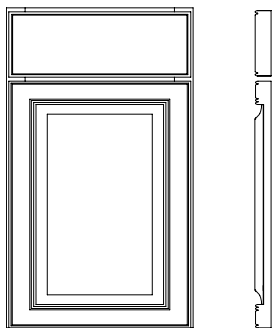

Ashfield White

AWS1

- Thermofoil on 3/4" thick MDF substrate
- Square raised center panel on wall and base doors
- Beaded frame profile
- Slab drawer front
- Full overlay door design
- Concealed hinge
- Decorative hardware is required

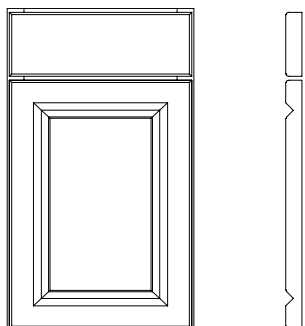

Evana Cream

ECS1

- Thermofoil on 3/4" thick MDF substrate
- Square raised center panel on wall and base doors
- Slab drawer front
- Full overlay door design
- Concealed hinge
- Decorative hardware is required

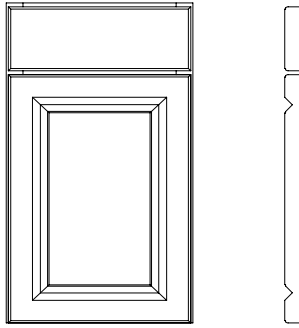

Evana White

EWS1

- Thermofoil on 3/4" thick MDF substrate
- Square raised center panel on wall and base doors
- Slab drawer front
- Full overlay door design
- Concealed hinge
- Decorative hardware is required

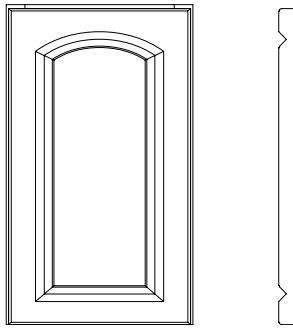

Evana Cathedral Cream

ECR1

- Thermofoil on 3/4" thick MDF substrate
- Roman arched raised center panel on wall doors
- Square raised center panel on base doors
- Slab drawer front
- Full overlay door design
- Concealed hinge
- Decorative hardware is required

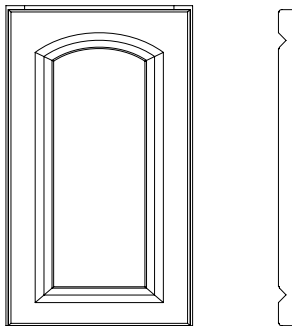

Evana Cathedral White

EWR1

- Thermofoil on 3/4" thick MDF substrate
- Roman arched raised center panel on wall doors
- Square raised center panel on base doors
- Slab drawer front
- Full overlay door design
- Concealed hinge
- Decorative hardware is required

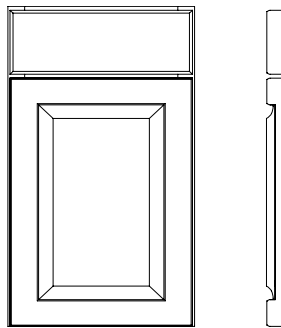

Findlay Cream

FCS1

- Thermofoil on 3/4" thick MDF substrate
- Square raised center panel on wall and base doors
- Slab drawer front
- Full overlay door design
- Concealed hinge
- Decorative hardware is required

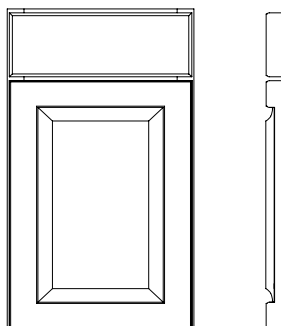

Findlay White

FWS1

- Thermofoil on 3/4" thick MDF substrate
- Square raised center panel on wall and base doors
- Slab drawer front
- Full overlay door design
- Concealed hinge
- Decorative hardware is required

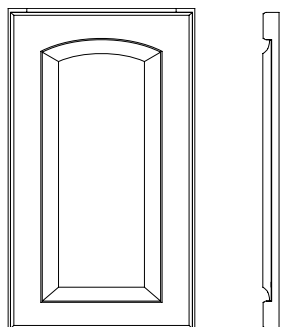

Findlay Cathedral Cream

FCR1

- Thermofoil on 3/4" thick MDF substrate
- Roman arched raised center panel on wall doors
- Square raised center panel on base doors
- Slab drawer front
- Full overlay door design
- Concealed hinge
- Decorative hardware is required

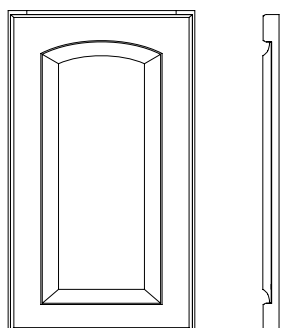

Findlay Cathedral White

FWR1

- Thermofoil on 3/4" thick MDF substrate
- Roman arched raised center panel on wall doors
- Square raised center panel on base doors
- Slab drawer front
- Full overlay door design
- Concealed hinge
- Decorative hardware is required

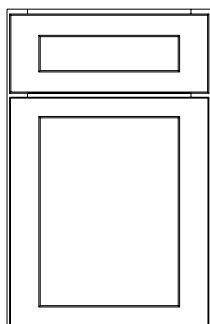

4 1/8"

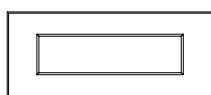

5 5/8"
to
6 1/8"

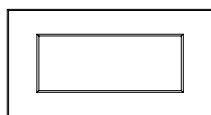

7 5/8"
&
higher

Northbrook

WP1

- Thermofoil on 3/4" thick MDF substrate
- Square recessed center panel on wall and base doors
- Drawer front varies depending on height
- Classic Drawer Front option available
- Full overlay door design
- Concealed hinge
- Decorative hardware is required

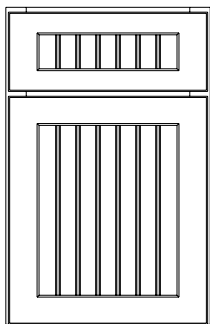

4 1/8"

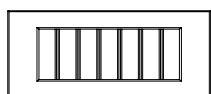

5 5/8"
&
higher

Polarcrest

ND1

- Thermofoil on 3/4" thick MDF substrate
- Square recessed beaded panel on wall and base doors
- Recessed panel beaded drawer front
- Grooves are 1 1/2" on center
- Classic Drawer Front option available
- Full overlay door design
- Concealed hinge
- Decorative hardware is required

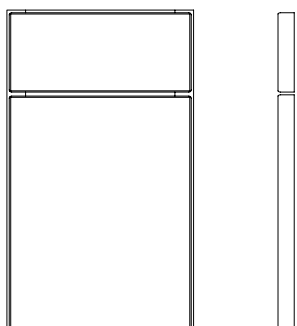

Sydney Cream

SCS1

- Thermofoil on 3/4" thick MDF substrate
- Slab with square edges on wall & base doors
- Slab drawer front
- Full overlay door design
- Concealed hinge
- Decorative hardware is required

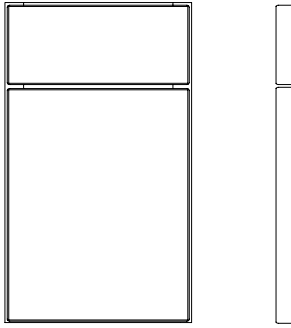

Sydney White

SWS1

- Thermofoil on 3/4" thick MDF substrate
- Slab with square edges on wall & base doors
- Slab drawer front
- Full overlay door design
- Concealed hinge
- Decorative hardware is required

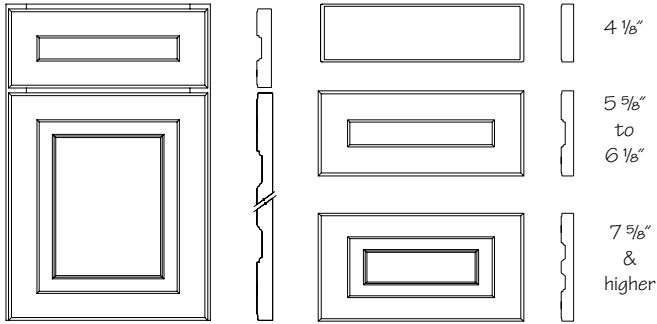

Sheridan

SHD1

- Thermofoil on 3/4" thick MDF substrate
- Square raised center panel on wall and base doors
- Drawer front varies depending on height
- Full overlay door design
- Concealed hinge
- Decorative hardware is required



Remember, all laminate and thermofoil door styles will have a natural birch interior and a White or Cream Viraguard exterior. Also, the underside of the cabinets are natural birch. To cover the underside, order an Under Cabinet Panel.

Maple

Hard Maple is a strong, close-grained wood that is predominantly off-white in color, although it also contains light hues of yellow-brown and pink. Hard Maple occasionally contains light tan or small dark mineral streaks.

Premium Burnished Finishes

(available with an upcharge)
 Burnished Ginger †
 Burnished Chestnut †
 Burnished Praline †
 Burnished Cinnamon †
 Burnished Rye †

Premium Highlight Finishes

(available with an upcharge)
 Natural w/Cocoa
 Highlight ▲
 Honey Spice w/Mocha
 Highlight ▲
 Praline w/Mocha
 Highlight †

Premium Paint w/Glaze Finishes

(available with an upcharge)
 Biscotti w/Coconut Glaze *
 Canvas w/Cocoa Glaze *
 Biscotti w/Cocoa Glaze *
 Cardinal w/Onyx Glaze *
 Sage w/Cocoa Glaze *
 Sage w/Onyx Glaze *
 Mushroom w/Cocoa Glaze *
 Dove White w/Cocoa Glaze *
 Willow w/Cocoa Glaze *

Premium Painted Finishes

(available with an upcharge)
 Onyx ■
 Biscotti ■
 Canvas ■
 Dove White ■
 Willow ■
 Cardinal ■
 Sage ■
 Mushroom ■

Premium Stain w/Glaze Finishes

(available with an upcharge)
 Ginger w/Sable Glaze *
 Rye w/Onyx Glaze *
 Rye w/Sable Glaze *
 Praline w/Onyx Glaze *
 Cinnamon w/Onyx Glaze *
 Chestnut w/Onyx Glaze *

Standard Stains

Chestnut
 Honey Spice
 Natural
 Toffee
 Cognac
 Caramel
 Praline
 Cinnamon
 Parchment
 Rye

- † Available on full overlay solid panel doors, except Mandolay
- ▲ Not available on Avery, Brookfield, Laurelwood, North Hampton, and Seton door styles
- ‡ Available on selected Maple door styles. See finish availability chart for your specific door style.
- * Not available on Avery
- Not available on Mandolay

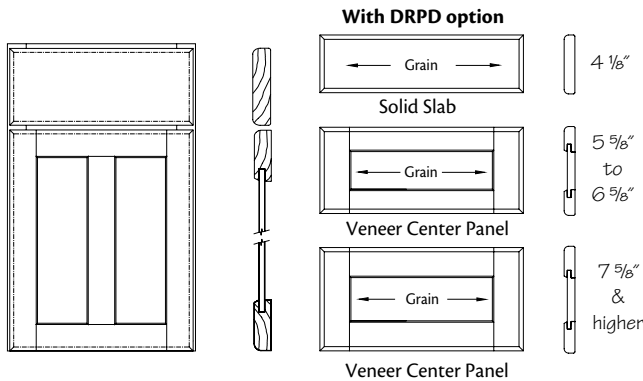

Amhurst

W11

- Solid wood door frame with 2 1/4" stiles and rails
- Single or multiple side by side veneer recessed panels on wall and base doors
- Slab drawer front
- Deluxe Recessed Panel Drawer Front available
- Full overlay door design
- Glass door options have no center divider
- Concealed hinge
- Decorative hardware is required
- See Door Configuration Chart for panel arrangement

Door Configuration Chart

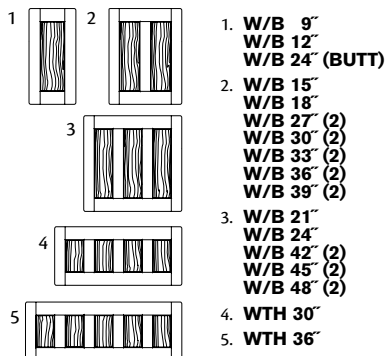

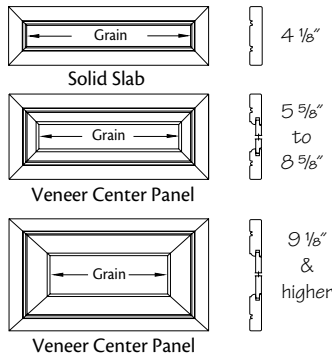
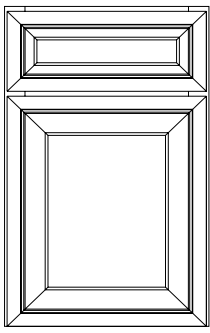

Argonne Maple

ASMD1

- Solid wood mitered door frame with 3" stiles and rails
- Square veneer recessed panel on wall and base doors
- Drawer front varies depending on height
- Full overlay door design
- Concealed hinge
- Decorative hardware is required
- Optional Faux Hinge available; see Decorative Hardware section of this book

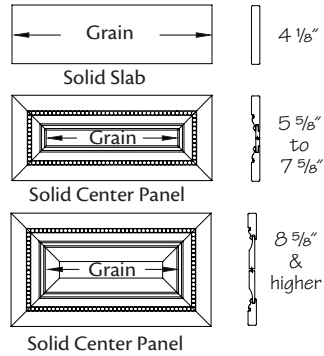
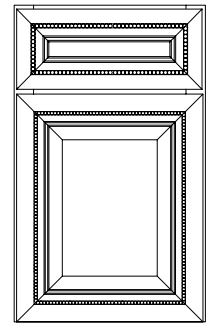

Astoria Maple

ALM1

- Solid wood mitered door frame with 2 1/2" stiles and rails
- Square solid raised panel on wall and base doors
- Door frame features inset beaded molding
- Drawer front varies depending on height
- Full overlay door design
- Concealed hinge
- Decorative hardware is required

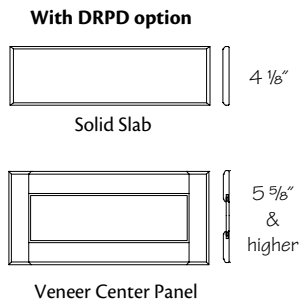
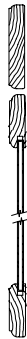
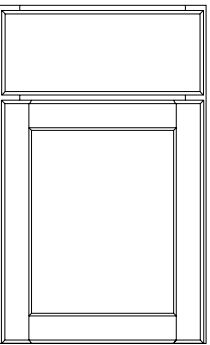

Atwater

ALS1

- Solid wood door frame with 2 3/16" stiles and rails
- Square veneer recessed panel on wall and base doors
- Slab drawer front
- Deluxe Recessed Panel Drawer Front available
- Full overlay door design
- Concealed hinge
- Decorative hardware is required

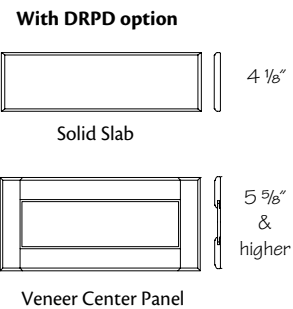
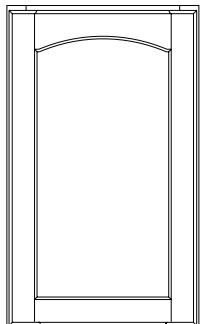

Atwater Cathedral

ALR1

- Solid wood door frame with 2 3/16" stiles and rails
- Roman arched veneer recessed panel wall doors
- Square veneer recessed panel base doors
- Slab drawer front
- Deluxe Recessed Panel Drawer Front available
- Full overlay door design
- Concealed hinge
- Decorative hardware is required

Avery

ML1

- Solid slab on wall and base doors
- Slab drawer front
- Full overlay door design
- Concealed hinge
- Decorative hardware is required

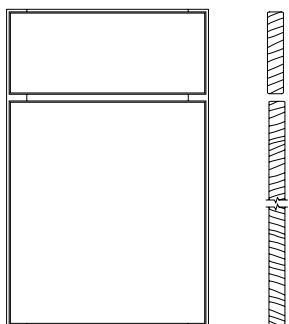

Belmont

2GV1

- Solid wood door frame with 2 3/16" stiles and rails
- Square veneer raised panel on wall and base doors
- Reverse bevel lip
- Slab drawer front
- 1/2" overlay door design
- Concealed or optional knife hinge
- Decorative hardware is *not* required

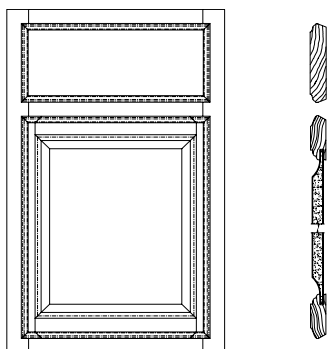

Bridgewater

ED1

- Solid wood door frame with 2 3/16" stiles and rails
- Square veneer raised panel on wall and base doors
- 1" thick detailed drawer front
- Deluxe Raised Panel Drawer Front available
- Full overlay door design
- Concealed hinge
- Decorative hardware is required

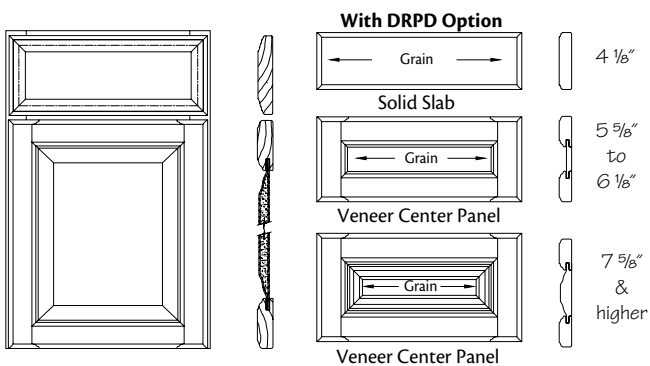

Bridgewater Cathedral

EDC1

- Solid wood door frame with 2 3/16" stiles and rails
- Roman arched veneer raised panel wall doors
- Square veneer raised panel base doors
- 1" thick detailed drawer front
- Deluxe Raised Panel Drawer Front available
- Full overlay door design
- Concealed hinge
- Decorative hardware is required

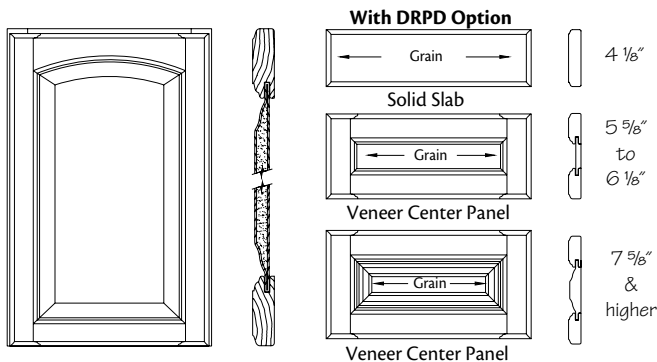

Brookfield Maple

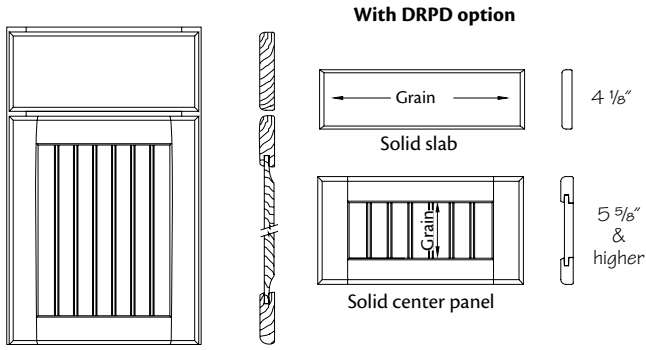

BWM1

- Solid wood door frame with 2 1/4" stiles and rails
- Square solid beaded recessed panel on wall and base doors
- Grooves are 1 1/2" on center
- Slab drawer front
- Deluxe Recessed Beaded Panel Drawer Front available
- Full overlay door design
- Concealed hinge
- Decorative hardware is required

Chadwick Maple

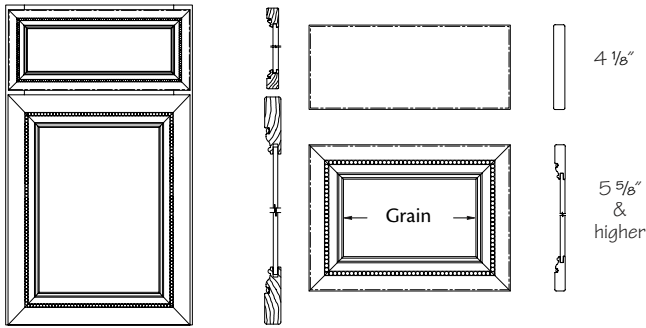

CTM1

- Solid wood mitered door frame with 2 1/2" stiles and rails
- Square veneer recessed panel on wall and base doors
- Door frame features inset beaded molding
- Drawer front varies depending on height
- Full overlay door design
- Concealed hinge
- Decorative hardware is required

Courtney Maple

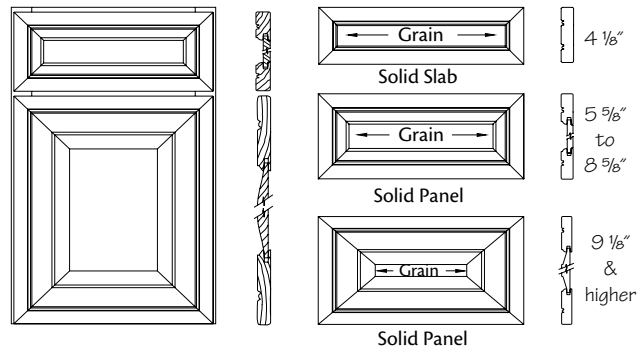

CRM1

- Solid wood mitered door frame with 3" stiles and rails
- Square solid raised panel on wall and base doors
- Drawer front varies depending on height
- Full overlay door design
- Concealed hinge
- Decorative hardware is required
- Optional Faux Hinge available; see Decorative Hardware section of this book

Dresden Maple

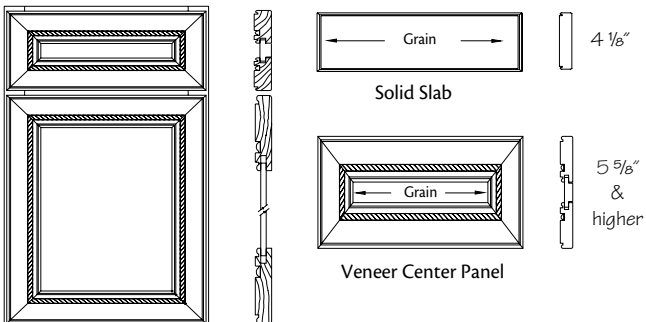

DRM1

- Solid wood mitered door frame with 2 1/2" stiles and rails
- Square veneer recessed panel on wall and base doors
- Doors feature inset rope molding surrounding center panel
- Five-piece recessed panel drawer front with inset rope molding
- Full overlay door design
- Concealed hinge
- Decorative hardware is required

New

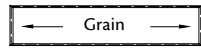
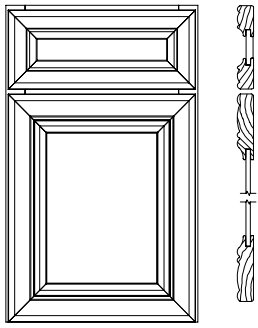

4 1/8"

Solid Slab

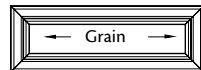

5 5/8"
to
12"

Veneer Center Panel

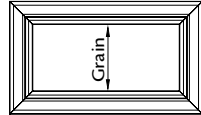

14 5/8"

Veneer Center Panel

Eldridge Maple Square

AA2M1

Color coding indicates new product, size or code

- Solid wood mitered door frame with 3" stiles and rails
- Square veneer recessed panel on wall and base doors
- Drawer front varies depending on height
- Full overlay door design
- Concealed hinge
- Decorative hardware is required

New

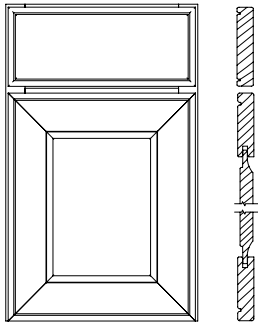

With DRPD Option

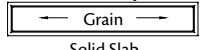

4 1/8"

Solid Slab

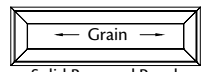

5 5/8"
to
7 5/8"

Solid Recessed Panel

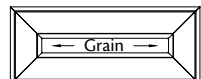

8 5/8"
to
12"

Solid Raised Panel

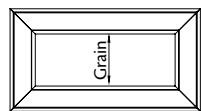

14 5/8"

Solid Raised Panel

Garrison Maple Square

AB1M1

Color coding indicates new product, size or code

- Solid wood mitered door frame with 3" stiles and rails
- Square solid raised panel on wall and base doors
- Slab drawer front
- Deluxe Raised Panel Drawer Front available
- Full overlay door design
- Concealed hinge
- Decorative hardware is required

Glasbern

2AY1

- Solid wood door frame with 2 3/16" stiles and rails
- Roman arched veneer raised panel wall doors
- Base doors same design as Belmont (2GV1)
- Reverse bevel lip
- Slab drawer front
- 1/2" overlay door design
- Concealed or optional knife hinge
- Decorative hardware is **not** required

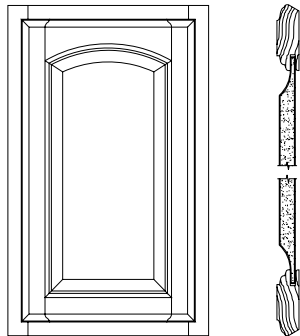

Glennberry Maple Square

GRM1

- Solid wood door frame with 2 1/2" stiles and rails
- Square solid raised panel on wall and base doors
- Applied decorative molding
- Drawer front varies depending on height
- Full overlay door design
- Concealed hinge
- Decorative hardware is required

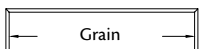
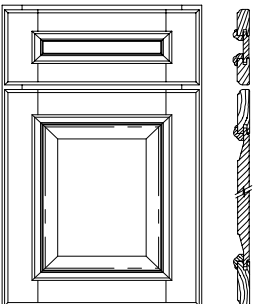

4 1/8"

Solid Slab

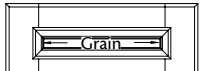

5 5/8"
to
7 5/8"

Solid Center Panel

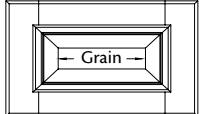

8 5/8"
to
14 5/8"

Solid Center Panel

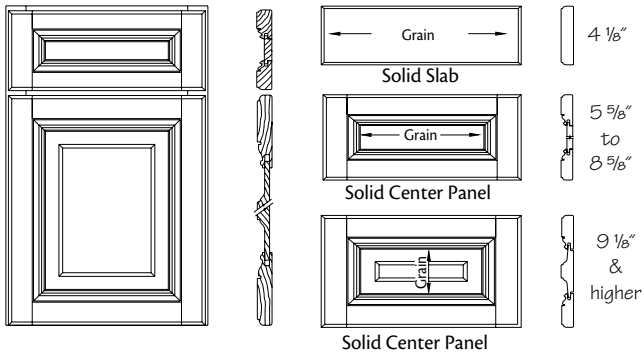

Halstead Maple

HLM1

- Solid wood door frame with 2 3/4" stiles and rails
- Door frame features "picture frame" style inset molding
- Square solid raised panel on wall and base doors
- Drawer front varies depending on height
- Full overlay door design
- Concealed hinge
- Decorative hardware is required

Hanley

2NG1

- Solid wood door frame with 2 3/16" stiles and rails
- Square veneer recessed panel on wall and base doors
- Reverse bevel lip
- Slab drawer front
- 1/2" overlay door design
- Concealed or optional knife hinge
- Decorative hardware is **not** required

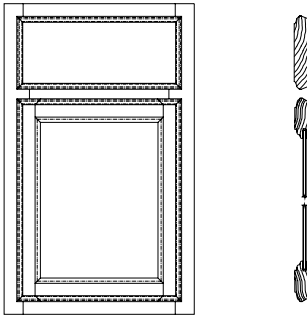

Hanley Cathedral

2NGC1

- Solid wood door frame with 2 3/16" stiles and rails
- Roman arched veneer recessed panel wall doors
- Square veneer recessed panel base doors
- Reverse bevel lip
- Slab drawer front
- 1/2" overlay door design
- Concealed or optional knife hinge
- Decorative hardware is **not** required

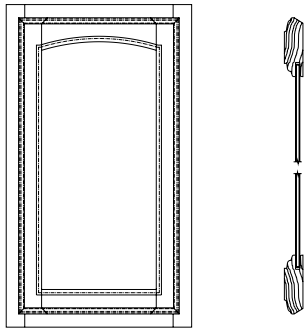

New

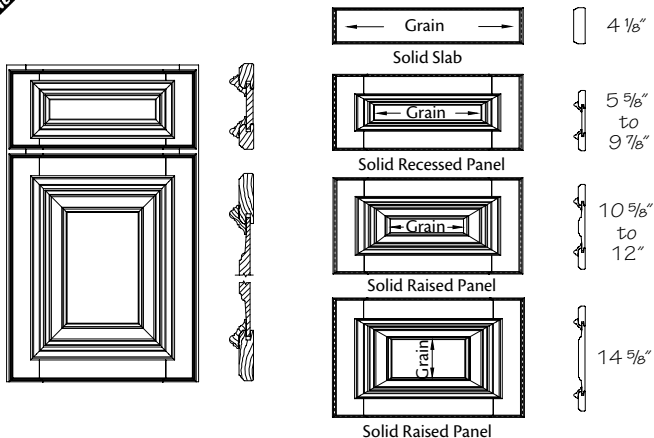

Harlowe Maple Square

AA3M1

- Color coding indicates new product, size or code*
- Solid wood door frame with 2 5/8" stiles and rails
 - Square solid raised panel on wall and base doors
 - Applied decorative molding
 - Drawer front varies depending on height
 - Full overlay door design
 - Concealed hinge
 - Decorative hardware is required

New

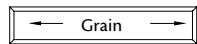
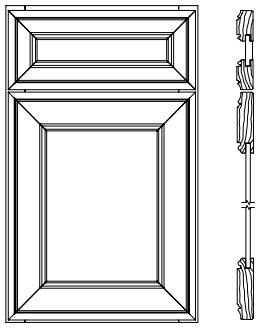

Solid Slab

4 1/8"

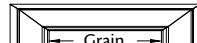

Veneer Center Panel

5 5/8"
to
12"

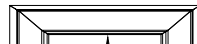

Veneer Center Panel

14 5/8"

Harrington Maple Square

AA6M1

Color coding indicates new product, size or code

- Solid wood mitered door frame with 3" stiles and rails
- Square veneer recessed panel on wall and base doors
- Drawer front varies depending on height
- Full overlay door design
- Concealed hinge
- Decorative hardware is required

Huntington

MP1

- Solid wood door frame with 2 3/16" stiles and rails
- Square veneer recessed panel on wall and base doors
- Five-piece drawer front
- Classic Drawer Front option available
- Full overlay door design
- Concealed hinge
- Decorative hardware is required

With CLDF option

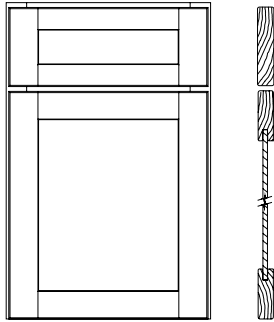

Solid Slab



New

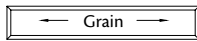
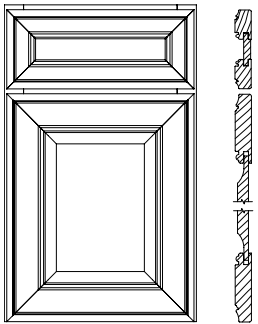

Solid Slab

4 1/8"

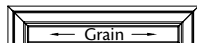

Solid Recessed Panel

5 5/8"
to
7 5/8"

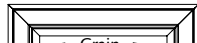

Solid Raised Panel

8 5/8"
to
12"

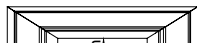

Solid Raised Panel

14 5/8"

Jamison Maple Square

AA5M1

Color coding indicates new product, size or code

- Solid wood door frame with 3" stiles and rails
- Square solid raised panel on wall and base doors
- Drawer front varies depending on height
- Full overlay door design
- Concealed hinge
- Decorative hardware is required

New

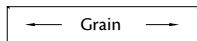
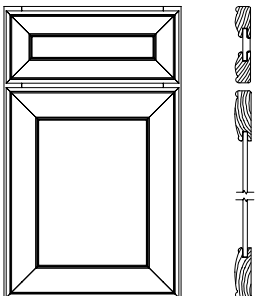

Solid Slab

4 1/8"

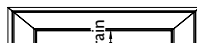

Veneer Center Panel

5 5/8"
to
6 1/8"

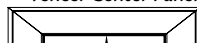

Veneer Center Panel

7 5/8"
and
higher

Judson Maple Square

AB5M1

Color coding indicates new product, size or code

- Solid wood mitered door frame with 2 3/4" stiles and rails
- Square veneer recessed panel on wall and base doors
- Drawer front varies depending on height
- Wood grain orientation on drawer fronts is vertical, unless noted
- Full overlay door design
- Concealed hinge
- Decorative hardware is required

New

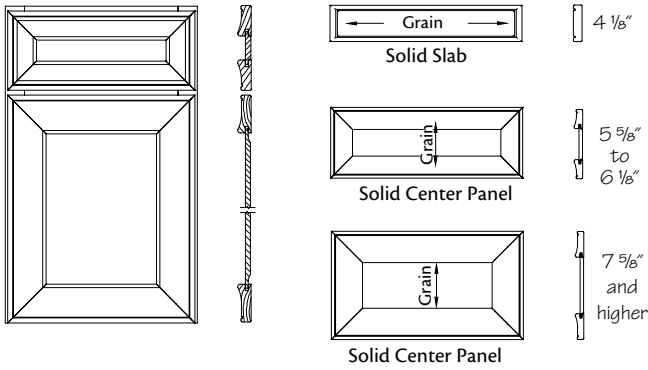

Kendrick Maple Square

AB6M1

Color coding indicates new product, size or code

- Solid wood mitered door frame with 3" stiles and rails
- Square solid recessed panel on wall and base doors
- Drawer front varies depending on height
- Wood grain orientation on drawer fronts is vertical, unless noted
- Full overlay door design
- Concealed hinge
- Decorative hardware is required

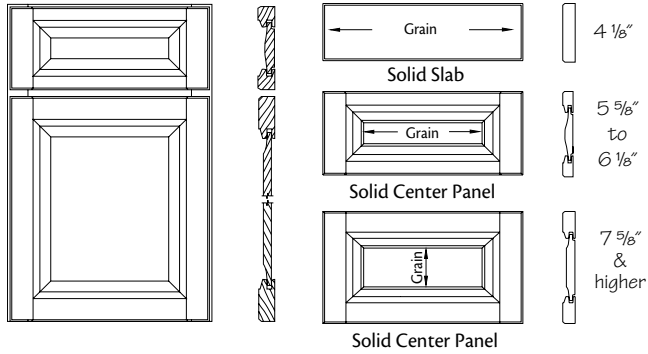

Knollwood Maple Square

PKM1

- Solid wood door frame with 2 3/16" stiles and rails
- Square solid raised panel on wall and base doors
- Drawer front varies depending on height
- Full overlay door design
- Concealed hinge
- Decorative hardware is required

New

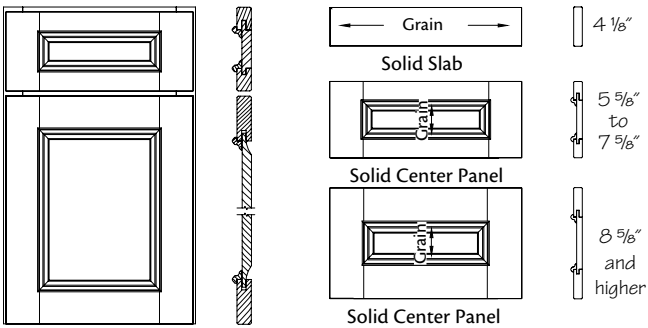

Lincoln Maple Square

AB3M1

Color coding indicates new product, size or code

- Solid wood door frame with 2 5/8" stiles and rails
- Square solid recessed panel on wall and base doors
- Drawer front varies depending on height
- Wood grain orientation on drawer fronts is vertical, unless noted
- Full overlay door design
- Concealed hinge
- Decorative hardware is required

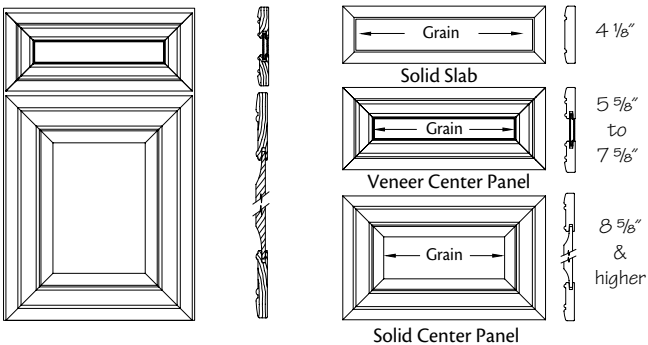

Lindsay Maple

BLM1

- Solid wood mitered door frame with 2 3/4" stiles and rails
- Square solid raised panel on wall and base doors
- Drawer front varies depending on height
- Full overlay door design
- Concealed hinge
- Decorative hardware is required

Lockeford Maple

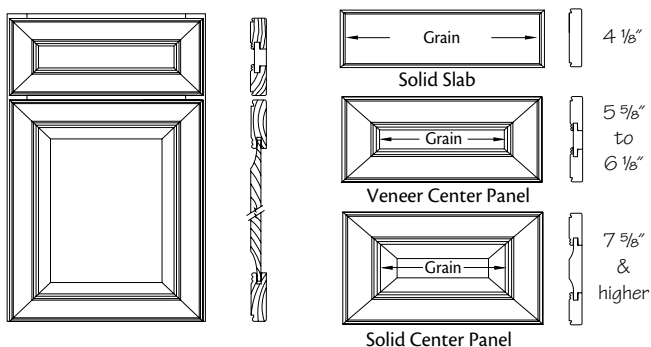

LCM1

- Solid wood mitered beaded door frame with 2 3/16" stiles and rails
- Square solid raised panel on wall and base doors
- Drawer front varies depending on height
- Full overlay door design
- Concealed hinge
- Decorative hardware is required

Mandolay Maple

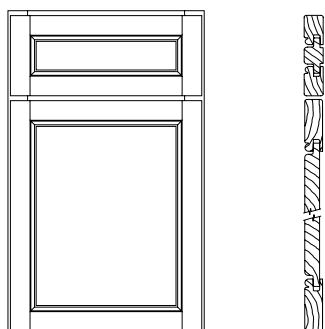

PVM1

- Solid wood beaded door frame with 2 3/16" stiles and rails
- Square solid raised panel on wall and base doors
- Five-piece raised panel beaded drawer front
- Full overlay door design
- Concealed hinge
- Decorative hardware is required

Marquette Maple Roman-Half

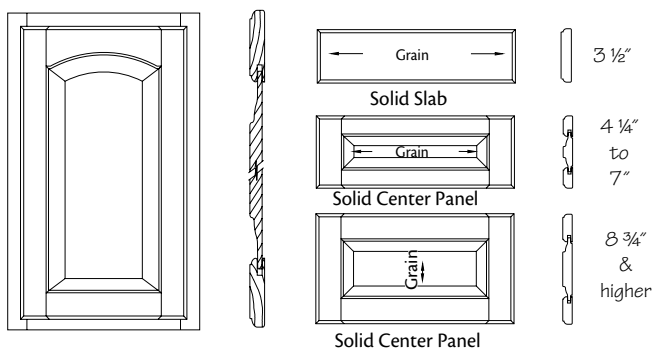

TWAM1

- Solid wood door frame with 2 3/16" stiles and rails
- Roman arched solid raised panel wall doors
- Square solid raised panel base doors
- Drawer front varies depending on height
- Classic Drawer Front option available
- 1/2" overlay door design
- Concealed hinge
- Decorative hardware is required

Marquette Maple Square-Half

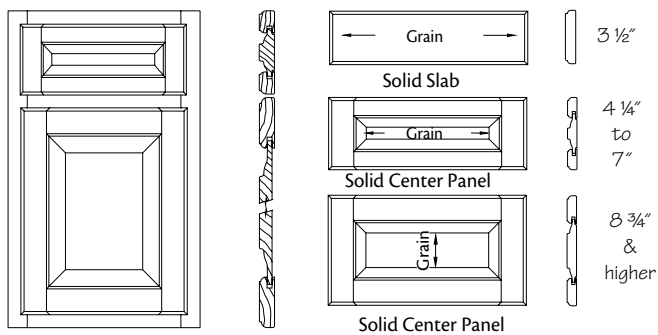

TWSM1

- Solid wood door frame with 2 3/16" stiles and rails
- Square solid raised panel on wall and base doors
- Drawer front varies depending on height
- Classic Drawer Front option available
- 1/2" overlay door design
- Concealed hinge
- Decorative hardware is required

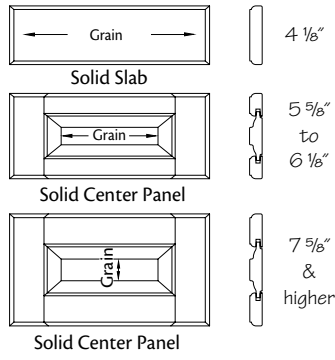
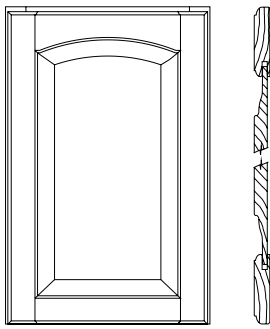

Marquette Maple Roman-Full

PWM1

- Solid wood door frame with 2 3/16" stiles and rails
- Roman arched solid raised panel wall doors
- Square solid raised panel base doors
- Drawer front varies depending on height
- Classic Drawer Front option available
- Full overlay door design
- Concealed hinge
- Decorative hardware is required

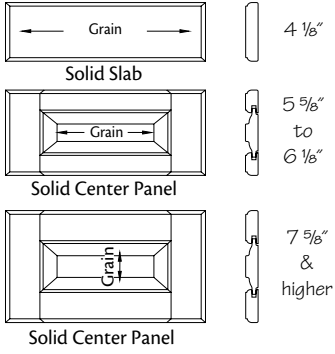
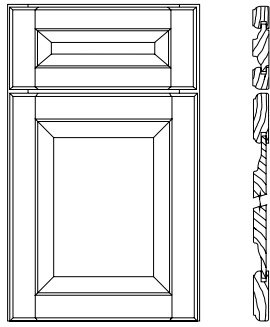

Marquette Maple Square-Full

MTM1

- Solid wood door frame with 2 3/16" stiles and rails
- Square solid raised panel on wall and base doors
- Drawer front varies depending on height
- Classic Drawer Front option available
- Full overlay door design
- Concealed hinge
- Decorative hardware is required

New

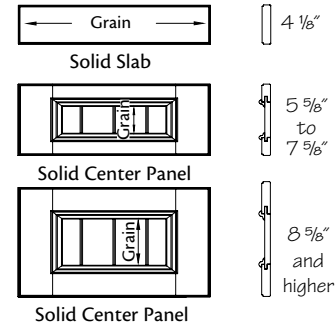
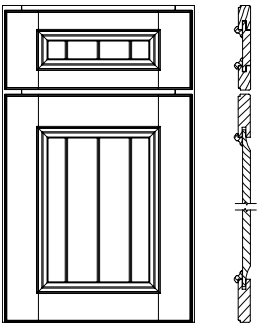

North Hampton Maple Square

AA9M1

- Color coding indicates new product, size or code*
- Solid wood door frame with 3" stiles and rails
 - Square solid v-grooved recessed panel on wall and base doors
 - Grooves are 2 1/2" on center
 - Applied decorative molding
 - Wood grain orientation on drawer fronts is vertical, unless noted
 - Drawer front varies depending on height
 - Full overlay door design
 - Concealed hinge
 - Decorative hardware is required

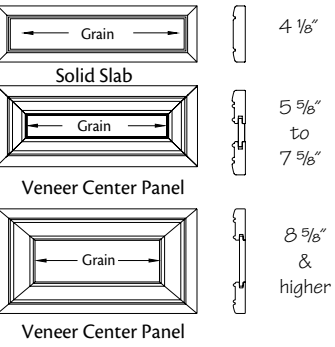
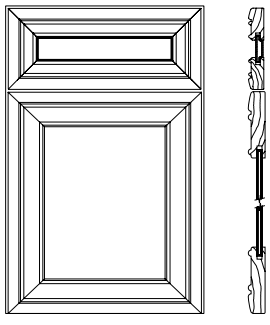

Northwicke Maple

NBM1

- Solid wood mitered door frame with 2 3/4" stiles and rails
- Square veneer recessed panel on wall and base doors
- Drawer front varies depending on height
- Full overlay door design
- Concealed hinge
- Decorative hardware is required

Parker House Maple

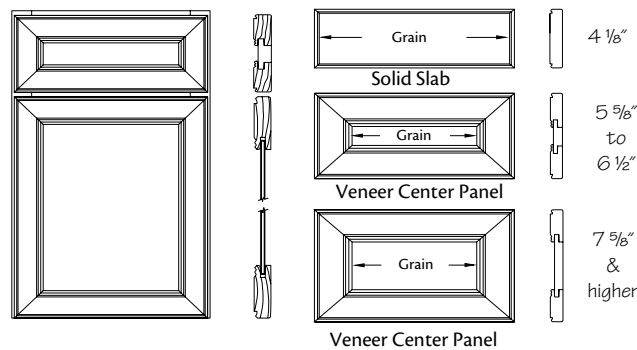

PDM1

- Solid wood mitered beaded door frame with 2 3/16" stiles and rails
- Square veneer recessed panel on wall and base doors
- Drawer front varies depending on height
- Full overlay door design
- Concealed hinge
- Decorative hardware is required

New

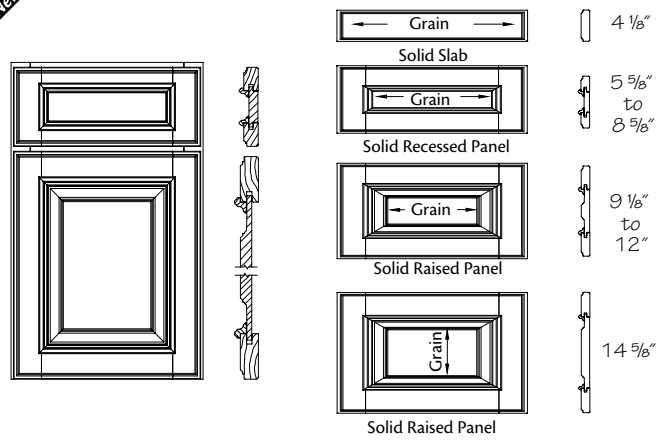

Patterson Maple Square

AA4M1

- Color coding indicates new product, size or code*
- Solid wood door frame with 2 3/16" stiles and rails
 - Square solid raised panel on wall and base doors
 - Applied decorative molding
 - Drawer front varies depending on height
 - Full overlay door design
 - Concealed hinge
 - Decorative hardware is required

Putnam Maple

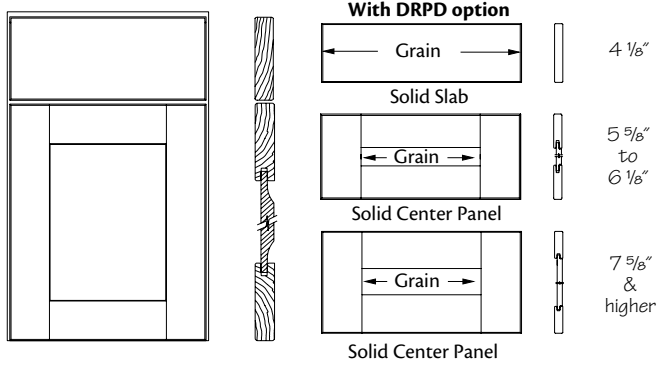

DRHM1

- Solid wood door frame with 3" stiles and rails
- Square solid recessed panel on wall and base doors
- Slab drawer front
- Deluxe Recessed Panel Drawer Front available
- Full overlay door design
- Concealed hinge
- Decorative hardware is required

New

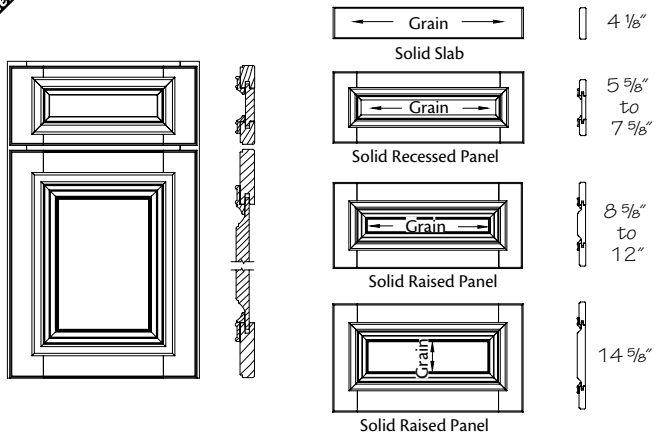

Richland Maple Square

AA7M1

- Color coding indicates new product, size or code*
- Solid wood door frame with 2 5/8" stiles and rails
 - Square solid raised panel on wall and base doors
 - Applied decorative molding
 - Drawer front varies depending on height
 - Full overlay door design
 - Concealed hinge
 - Decorative hardware is required

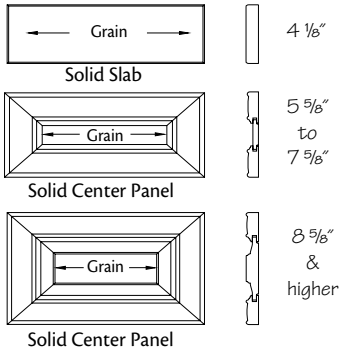
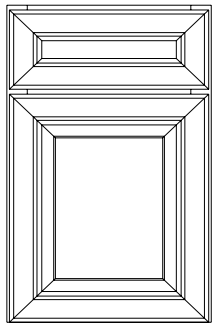

Rutherford Maple

RTM1

- Solid wood mitered door frame with 2 3/8" stiles and rails
- Square solid raised panel on wall and base doors
- Drawer front varies depending on height
- Full overlay door design
- Concealed hinge
- Decorative hardware is required

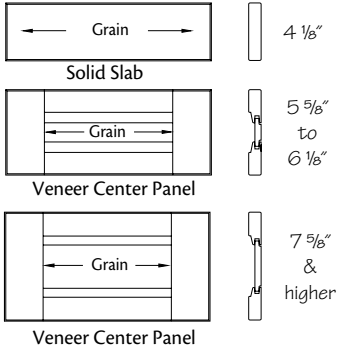
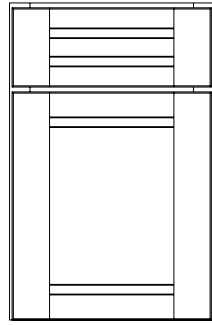

Sedona Maple

SNM1

- Solid wood door frame with 2 3/4" stiles and rails
- Square veneer recessed panel on wall and base doors
- Drawer front varies depending on height
- Classic Drawer Front option available
- Full overlay door design
- Concealed hinge
- Decorative hardware is required

New

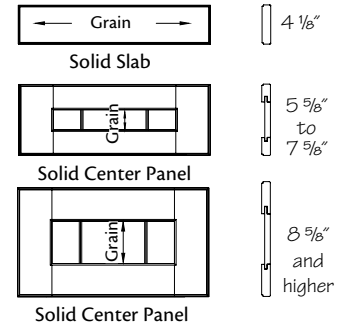
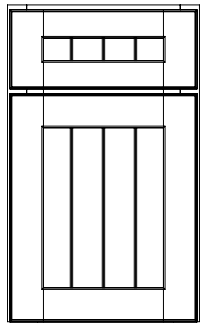

Seton Maple Square

AB0M1

- Color coding indicates new product, size or code*
- Solid wood door frame with 2 5/8" stiles and rails
 - Square solid v-grooved recessed panel on wall and base doors
 - Grooves are 2 1/2" on center
 - Wood grain orientation on drawer fronts is vertical, unless noted
 - Drawer front varies depending on height
 - Full overlay door design
 - Concealed hinge
 - Decorative hardware is required

New

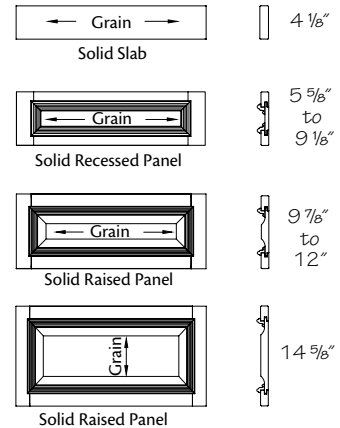
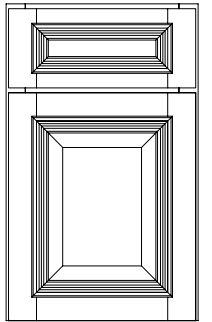

Smithton Maple Square

AA8M1

- Color coding indicates new product, size or code*
- Solid wood door frame with 2 3/16" stiles and rails
 - Square solid raised panel on wall and base doors
 - Applied decorative molding
 - Drawer front varies depending on height
 - Full overlay door design
 - Concealed hinge
 - Decorative hardware is required

New

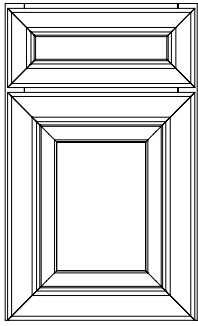

Solid Slab

4 1/8"

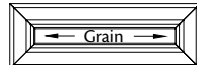

Solid Recessed Panel

5 5/8"
to
7 5/8"

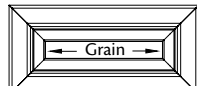

Solid Raised Panel

8 5/8"
to
12"

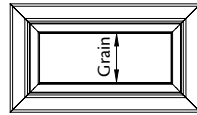

Solid Raised Panel

14 5/8"

Tennyson Maple Square

AA0M1

Color coding indicates new product, size or code

- Solid wood mitered door frame with 2 5/8" stiles and rails
- Square solid raised panel on wall and base doors
- Drawer front varies depending on height
- Full overlay door design
- Concealed hinge
- Decorative hardware is required

New

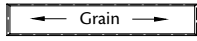
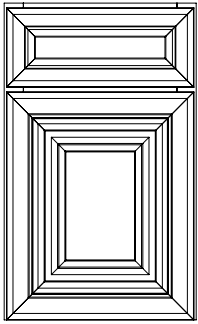

Solid Slab

4 1/8"

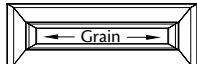

Solid Recessed Panel

5 5/8"
to
9 1/2"

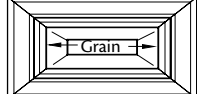

Solid Raised Panel

10 5/8"
to
12"

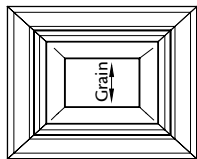

Solid Raised Panel

14 5/8"

Vanderbilt Maple Square

AA1M1

Color coding indicates new product, size or code

- Solid wood mitered door frame with 3" stiles and rails
- Square solid raised panel on wall and base doors
- Drawer front varies depending on height
- Full overlay door design
- Concealed hinge
- Decorative hardware is required

Westboro Maple

WLM1

- Solid wood door frame with 2 3/4" stiles and rails
- Square solid raised panel on wall and base doors
- Slab drawer front
- Deluxe Raised Panel Drawer Front available
- Full overlay door design
- Concealed hinge
- Decorative hardware is required

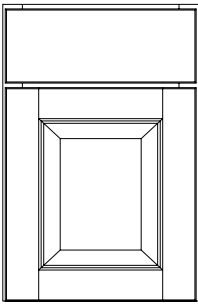

With DRPD option

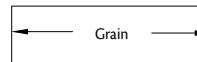

Solid Slab

4 1/8"

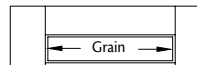

Veneer Center Panel

5 5/8"
to
9 1/2"

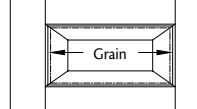

Solid Center Panel

10 5/8"
&
higher

Maple-Quartersawn

Hard Maple is a strong, close-grained wood that is predominantly off-white in color, although it also contains light hues of yellow-brown and pink. Hard Maple occasionally contains light tan or small dark mineral streaks. Quartersawn refers to the method of cutting the Maple. Boards are cut through the radius of the rings allowing wavy grain and flaked patterns to show on the face.

Premium Painted Finishes

(available with an upcharge)

Cardinal

Sage

Mushroom

Onyx

Biscotti

Canvas

Dove White

Willow

Standard Stains

Parchment

Rye

Cinnamon

Chestnut

Caramel

Honey Spice

Natural

Praline

Toffee

New

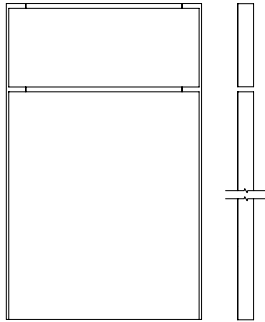

Brockton Maple Square

AB4M1

Color coding indicates new product, size or code

- Quartersawn veneer slab on wall and base doors
- Quartersawn veneer slab drawer fronts
- Wood grain orientation on drawer fronts is vertical, unless noted
- Full overlay door design
- Concealed hinge
- Decorative hardware is required

Oak

Red Oak is a strong, open-grained wood that has a range in color of white, yellow and pink. Red Oak is sometimes streaked with green, yellow and black mineral deposits and may contain some wide grain.

Premium Highlight Finishes

(available with an upcharge)

Natural w/Cocoa Highlight ▲

Honey Spice w/Mocha Highlight ▲

Premium Painted Finishes

(available with an upcharge)

Onyx

Premium Stain w/Glaze Finishes

(available with an upcharge)

Chocolate w/Mocha Glaze

Rye w/Onyx Glaze

Rye w/Sable Glaze

Autumn Blush w/Onyx Glaze

Standard Stains

Autumn Blush

Fawn

Honey Spice

Natural

Kaffe

Cognac

Peppercorn

Toffee

Rye

▲ Not available on Brookfield Oak

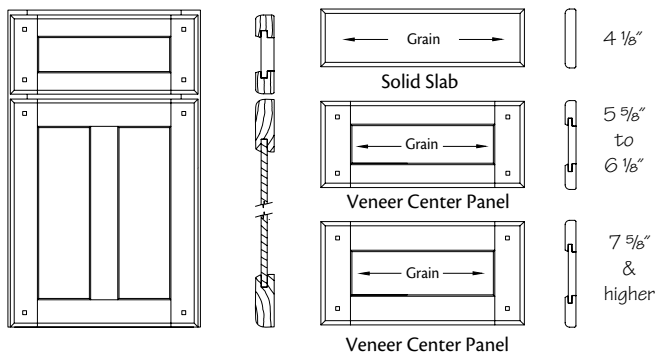

Abington Oak

TMKO1

- Solid wood door frame with walnut pegs in 2 1/4" stiles and rails
- Single or multiple side by side veneer recessed panels on wall and base doors
- Glass door options have no center divider
- Five-piece recessed drawer front with walnut pegs
- When drawer fronts are supplied as a solid slab, they will **not** have corner pegs
- Full overlay door design
- Concealed hinge
- Decorative hardware is required
- See Door Configuration Chart for panel arrangement

Door Configuration Chart

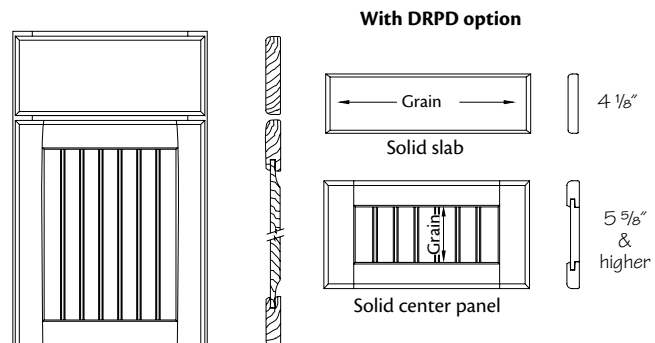
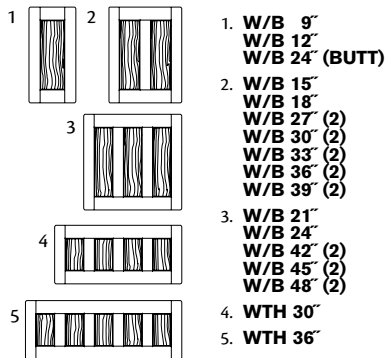

Brookfield Oak

SMG1

- Solid wood door frame with 2 1/4" stiles and rails
- Square solid beaded recessed panel on wall and base doors
- Grooves are 1 1/2" on center
- Slab drawer front
- Deluxe Recessed Beaded Panel Drawer Front available
- Full overlay door design
- Concealed hinge
- Decorative hardware is required

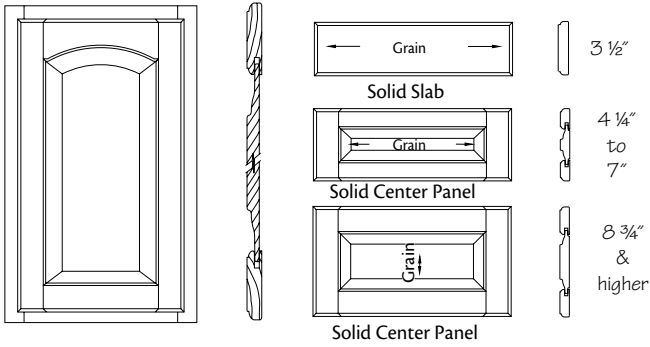

Marquette Oak Roman-Half

TWAO1

- Solid wood door frame with 2 3/16" stiles and rails
- Roman arched solid raised panel wall doors
- Square solid raised panel base doors
- Drawer front varies depending on height
- Classic Drawer Front option available
- 1/2" overlay door design
- Concealed hinge
- Decorative hardware is required

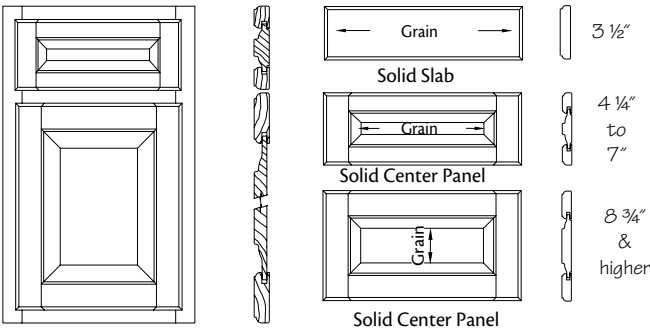

Marquette Oak Square-Half

TWSO1

- Solid wood door frame with 2 3/16" stiles and rails
- Square solid raised panel on wall and base doors
- Classic Drawer Front option available
- Drawer front varies depending on height
- 1/2" overlay door design
- Concealed hinge
- Decorative hardware is required

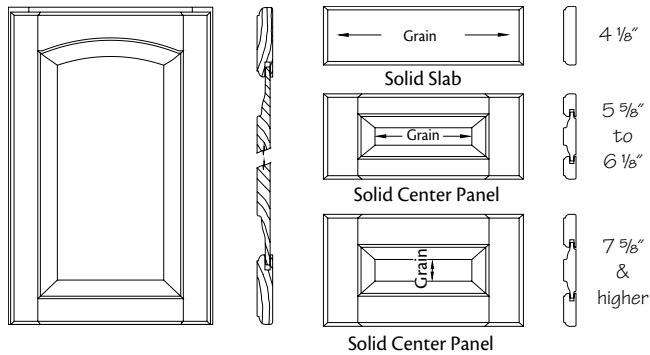

Marquette Oak Roman-Full

PWO1

- Solid wood door frame with 2 3/16" stiles and rails
- Roman arched solid raised panel wall doors
- Square solid raised panel base doors
- Drawer front varies depending on height
- Classic Drawer Front option available
- Full overlay door design
- Concealed hinge
- Decorative hardware is required

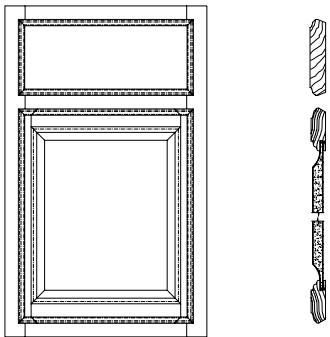

Milton

2BN1

- Solid wood door frame with 2 3/16" stiles and rails
- Square veneer raised panel on wall and base doors
- Reverse bevel lip
- Slab drawer front
- 1/2" overlay door design
- Concealed or optional knife hinge
- Decorative hardware is *not* required

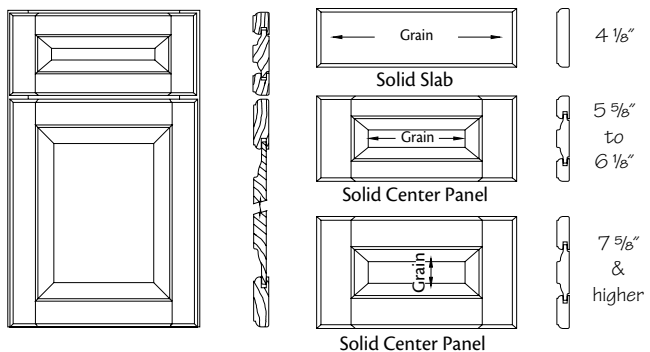

Marquette Oak Square-Full

MTO1

- Solid wood door frame with 2 3/16" stiles and rails
- Square solid raised panel on wall and base doors
- Drawer front varies depending on height
- Classic Drawer Front option available
- Full overlay door design
- Concealed hinge
- Decorative hardware is required

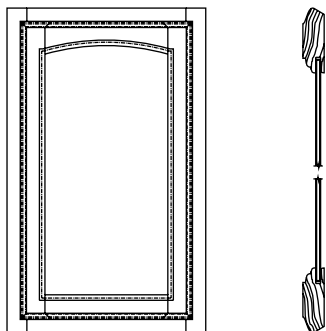

Ridgefield

2SWC1

- Solid wood door frame with 2 3/16" stiles and rails
- Roman arched veneer recessed panel wall doors
- Base doors same design as Stockton (2SW1)
- Reverse bevel lip
- Slab drawer front
- 1/2" overlay door design
- Concealed or optional knife hinge
- Decorative hardware is **not** required

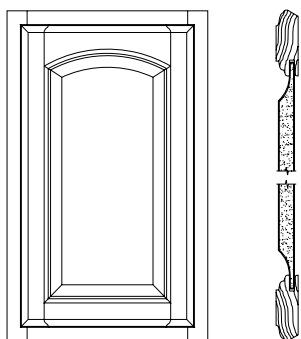

Saranac

2ABN1

- Solid wood door frame with 2 3/16" stiles and rails
- Roman arched veneer raised panel wall doors
- Base doors same design as Millton (2BN1)
- Reverse bevel lip
- Slab drawer front
- 1/2" overlay door design
- Concealed or optional knife hinge
- Decorative hardware is **not** required

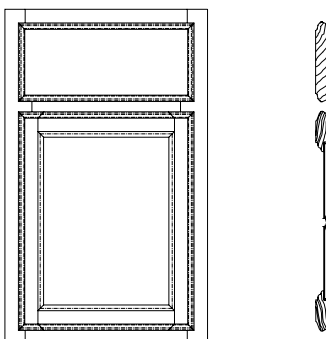

Stockton

2SW1

- Solid wood door frame with 2 3/16" stiles and rails
- Square veneer recessed panel on wall and base doors
- Reverse bevel lip
- Slab drawer front
- 1/2" overlay door design
- Concealed or optional knife hinge
- Decorative hardware is **not** required

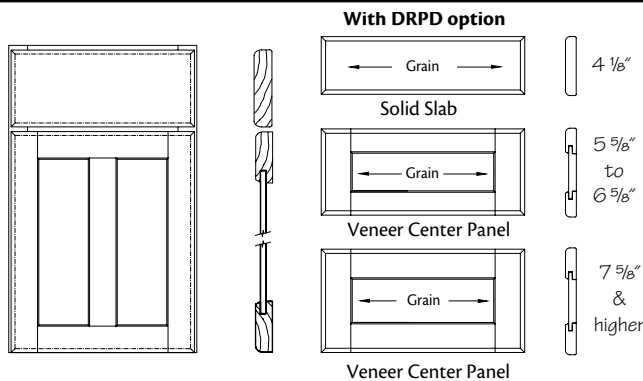

Townsend

TN1

- Solid wood door frame with 2 1/4" stiles and rails
- Single or multiple side by side veneer recessed panels on wall and base doors
- Slab drawer front
- Deluxe Recessed Panel Drawer Front available
- Glass door options have no center divider
- Full overlay door design
- Concealed hinge
- Decorative hardware is required
- See Door Configuration Chart for panel arrangement

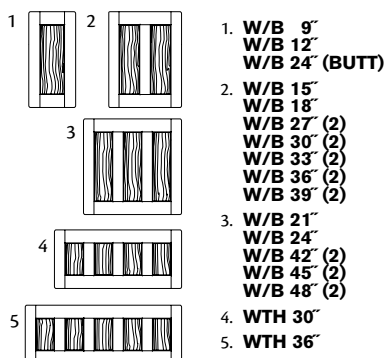

Door Configuration Chart

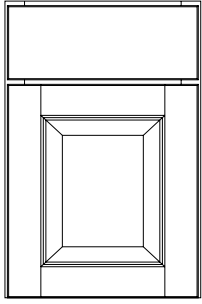

With DRPD option

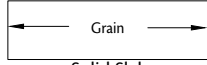

4 1/8"

Solid Slab

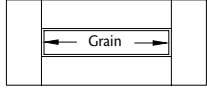

5 5/8"
to
9 1/2"

Veneer Center Panel

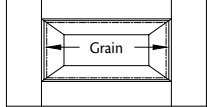

10 5/8"
&
higher

Solid Center Panel

Westboro Oak

WLO1

- Solid wood door frame with 2 3/4" stiles and rails
- Square solid raised panel on wall and base doors
- Slab drawer front
- Deluxe Raised Panel Drawer Front available
- Full overlay door design
- Concealed hinge
- Decorative hardware is required

Oak-Quartersawn

Red Oak is a strong open-grained wood that has a range in color of white, yellow and pink. Red Oak is sometimes streaked with green, yellow and black mineral deposits and may contain some wide grain. Quartersawn refers to the method of cutting the Red Oak. Boards are cut through the radius of the rings allowing wavy grain and flaked patterns to show on the face.

Premium Highlight Finishes
(available with an upcharge)
Natural w/Cocoa Highlight
Honey Spice w/Mocha Highlight

Premium Painted Finishes
(available with an upcharge)
Onyx

Premium Stain w/Glaze Finishes
(available with an upcharge)
Chocolate w/Mocha Glaze
Autumn Blush w/Onyx Glaze
Rye w/Onyx Glaze
Rye w/Sable Glaze

Standard Stains

Autumn Blush
Cognac ※
Fawn
Honey Spice
Kaffe
Natural
Peppercorn
Toffee
Rye

※ Not available on Brockton Oak Square doors

New

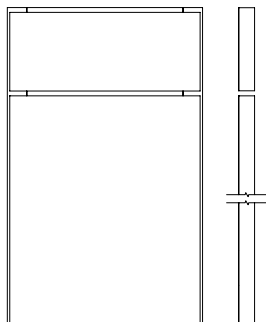

Brockton Oak Square

AB401

Color coding indicates new product, size or code

- Quartersawn veneer slab on wall and base doors
- Quartersawn veneer slab drawer fronts
- Wood grain orientation on drawer fronts is vertical, unless noted
- Full overlay door design
- Concealed hinge
- Decorative hardware is required

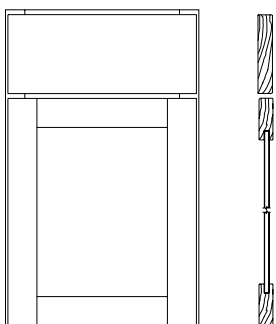

With DRPD option

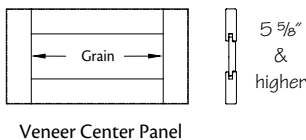
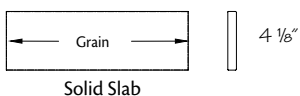

Melrose

MRO1

- Solid wood door frame with 2 3/16" stiles and rails
- Square red oak quartersawn veneer recessed center panel
- Solid red oak quartersawn slab drawer fronts
- Deluxe Recessed Panel Drawer Front available
- Full overlay door design
- Concealed hinge
- Decorative hardware is required

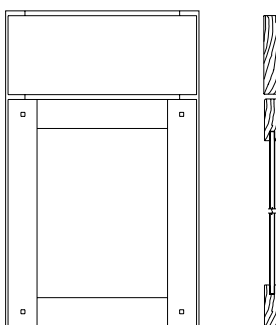

With DRPD option

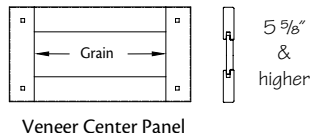
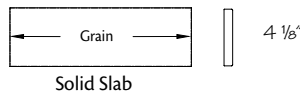

Morristown

SU1

- Solid wood door frame with 2 3/16" stiles and rails
- Oak pegged corners
- Square red oak quartersawn veneer recessed center panel
- Solid red oak quartersawn slab drawer fronts
- Deluxe Recessed Panel Drawer Front available
- Full overlay door design
- Concealed hinge
- Decorative hardware is required

New

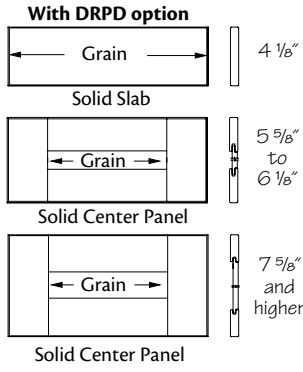
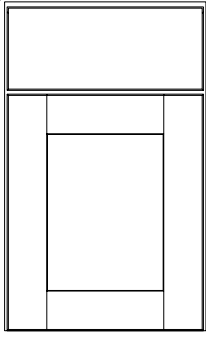

Putnam Oak Square

AB201

Color coding indicates new product, size or code

- Solid wood door frame with 3" stiles and rails
- Square red oak quartersawn solid recessed center panel
- Solid red oak quartersawn slab drawer fronts
- Deluxe Recessed Panel Drawer Front available
- Full overlay door design
- Concealed hinge
- Decorative hardware is required