

Specifications subject to change without notice.

| | | |
|-------------|-------------|-----------|
| LVLK | •3 | •B |
| code | # of lights | finish |

Low Voltage Lighting Kit

(price book pg. L4)

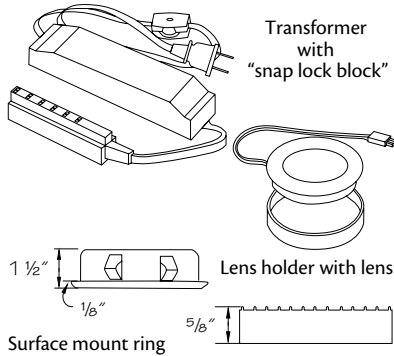

Two Lights

- LVLK•2•B** Black
- LVLK•2•ST** Stainless Finish
- LVLK•2•W** White

Three lights

- LVLK•3•B** Black
- LVLK•3•ST** Stainless Finish
- LVLK•3•W** White

- Lights may be surface or recess mounted
- Recessed mount requires a 2 1/8" hole
- Kit includes 20 watt xenon lights, transformer and "snap lock" wiring with on/off switch
- Complete instructions and mounting hardware included
- Bulbs are included
- Replacement bulbs available at hardware or lighting retailers
- Trim rings and surface rings included
- Will also accept 10 watt halogen or xenon bulbs

Touch Dimmer

(price book pg. L4)

TCDMR

- Four light settings
- Works in conjunction with all Low Voltage Light Kits
- Fixture or transformer plugs directly into dimmer
- Box and cords are white, removable Touch Pad is black
- Will **not** work with fluorescent lighting

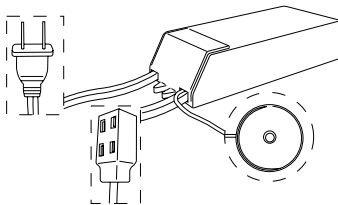

Six Foot Extension

(price book pg. L5)

EXTN

- Includes 6' wire
- White
- Maximum recommended length from light to transformer is 16 feet
- For use with low voltage lighting

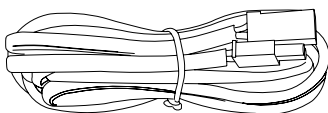

Round Switch For Low Voltage Lights

(price book pg. L5)

RNSW-B Black

RNSW-W White

- Includes 6' wire
- Recesses into 13/16" hole
- Switches can be placed between wiring block and transformer to control all the lights on one system or between light and wiring block for isolated control of each light

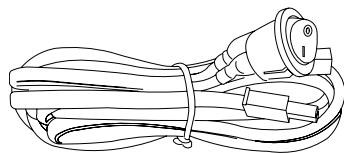

Decorative Cabinet Lighting

(price book pg. L5)

Two lights

DCL-2-ST

Three lights

DCL-3-ST

- Stainless finish
- Uses 20 watt xenon bulbs
- Includes one transformer and power cord
- Designed for surface mount installation under cabinet
- Complete instructions and mounting hardware included
- Bulbs are included
- Replacement bulbs available at hardware or lighting retailers
- Will also accept 10 watt halogen or xenon bulbs

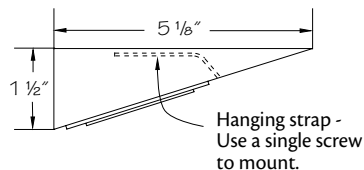
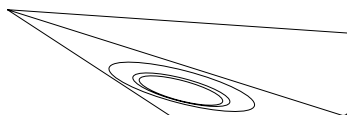

Decorative Task Lighting

(price book pg. L5)

Two lights

DTL-2-B Black

DTL-2-ST Stainless Finish

Three lights

DTL-3-B Black

DTL-3-ST Stainless Finish

- Uses 20 watt xenon bulbs
- Light housing is 2 3/4" high
- Housing swivels to adjust light direction
- Arm is approximately 14" long
- Includes one transformer and power cord
- Mounts over cabinet or shelf
- Simple two screw installation
- Clear glass cover
- Complete instructions and mounting hardware included
- Bulbs are included
- Replacement bulbs available at hardware or lighting retailers
- Will also accept 10 watt halogen or xenon bulbs

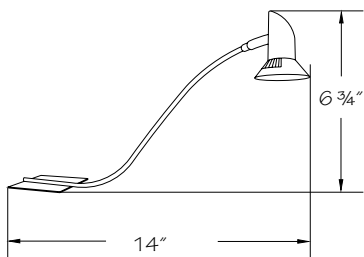

Not recommended for use over Wall Top Hinge (WTH). Door will collide with light fixture causing damage to both light fixture and door.

Fluorescent Linkable Light Strips

(price book pg. L5)

FLLSWM-11 10 1/2" long

FLLSWM-17 16 1/2" long

FLLSWM-28 27 3/4" long

- Aluminum-gray color
- Internal ballast with instant start-up
- Plug in or hardwire with optional Hardwire Box. Power cord included.
- Includes two light ready and two standard fixture mounting clips with mounting screws

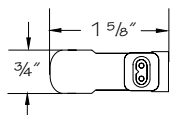
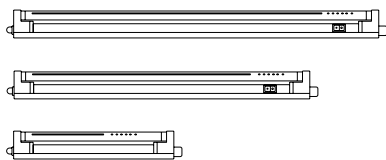

FLC

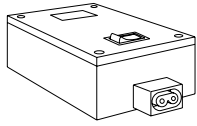
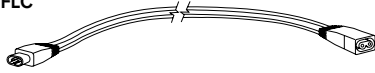

FLLSHWB

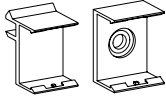

BOX.FMC

Fluorescent Linking Cord and Hardwire Box w/Switch

(price book pg. L5)

FLC-1

- 1' linking cord
- Aluminum-gray color
- Includes four wire management clips

FLC-4

- 4' linking cord
- Aluminum-gray color
- Includes eight wire management clips

FLLSHWB-AL

- Aluminum-gray color
- Maximum ten lights per Hardwire Box
- Includes several "knock outs" for power supply entry
- A linking cord is needed to link the box and the first light
- Hardwire Box cannot be used with Low Voltage Lighting

BOX.FMC

- Includes twenty light ready and twenty standard fixture mounting clips with mounting screws
- For use with Fluorescent Linkable Light Strips (FLLS) only
- Light-ready clips fit into groove on Light-ready Molding; see Molding Section of this book.

Linkable Light Strips

(price book pg. L5)

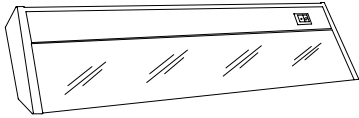

Aluminum Finish

- LLS-8-AL** 8" long
- LLS-16-AL** 16" long
- LLS-24-AL** 24" long
- LLS-32-AL** 32" long

White

- LLS-8-W** 8" long
- LLS-16-W** 16" long
- LLS-24-W** 24" long
- LLS-32-W** 32" long

- Uses 35 watt xenon bulbs
- Designed for hardwire installation
- Built-in Hi-Lo-Off switch
- Prismatic diffuser
- Low 1 1/2" profile
- Complete instructions and mounting hardware included
- Bulbs are included
- Replacement bulbs available at hardware or lighting retailers

Black

- LLS-8-B** 8" long
- LLS-16-B** 16" long
- LLS-24-B** 24" long
- LLS-32-B** 32" long

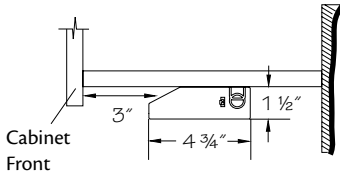

Cabinet Front

Linking Cord

(price book pg. L5)

Black

- LC-1-B** 1' long
- LC-4-B** 4' long

Gray

- LC-1-G** 1' long
- LC-4-G** 4' long

White

- LC-1-W** 1' long
- LC-4-W** 4' long

- For use with linkable light strips

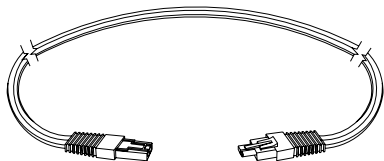

Interior Cabinet Lighting Kit

(price book pg. L5)

One Drawer

Fits cabinet width

- ICLK1824 -1D** 18" - 24"
- ICLK2736 -1D** 27" - 36"

Two Drawer

- ICLK1824 -2D** 18" - 24"
- ICLK2736 -2D** 27" - 36"

Three Drawer

- ICLK1824 -3D** 18" - 24"
- ICLK2736 -3D** 27" - 36"

For Lazy Susan

ICLK -LS

- Contains transformer, lights, automatic switch and wire management clips
- Cold cathode light for cool operation
- Automatic switch is activated by opening door
- No more than two lights can be connected to a single automatic switch

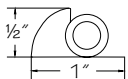

Fluorescent Linkable Puck Lighting

(price book pg. L5)

Three Lights

- FLPLKWM-3-AL** Aluminum Finish
- FLPLKWM-3-B** Black
- FLPLKWM-3-W** White

Five Lights

- FLPLKWM-5-AL** Aluminum Finish
- FLPLKWM-5-B** Black
- FLPLKWM-5-W** White

- Lights may be surface or recess mounted
- Recessed mount requires a 3 1/4" hole
- Each light is 7 watts
- Includes mounting hardware, power cords and roll switch
- Black roll switch supplied in Aluminum kit

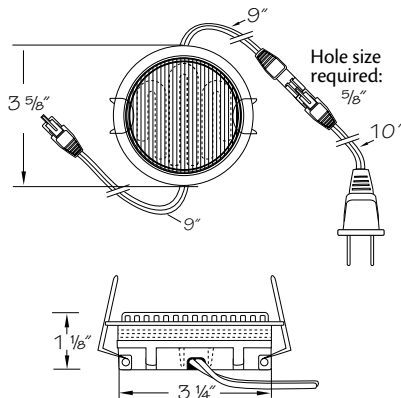

Fluorescent Puck Light Linking Cords

(price book pg. L5)

- FPLLC-B** Black
- FPLLC-W** White

- 24" long

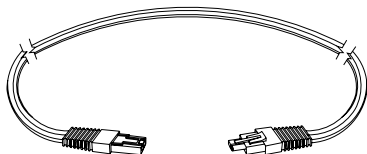

Fluorescent Puck Light Hardwire Box

(price book pg. L5)

- FPLHWB-B** Black
- FPLHWB-W** White

- Includes Hardwire Box Adaptor
- Maximum ten lights per Hardwire Box
- Includes several "knock outs" for power supply entry
- A linking cord is need to link the box and the first light

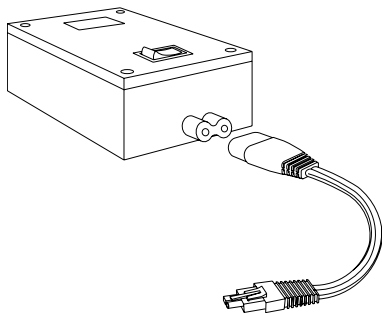

Fluorescent Puck Light Round Switch Kit

(price book pg. L5)

- FPLRSK-B** Black
- FPLRSK-W** White

- Includes 6' wire
- Recesses into 13/16" hole
- Switches can be placed between wiring block and transformer to control all the lights on one system or between light and wiring block for isolated control of each light

