

# Supports and Valances

## Construction Options and Modifications

- --- Available with an upcharge
- ◆ --- Included as standard
- ☆ --- Available with exceptions
- (Blank) - Not available

- B --- Birch
- C --- Cherry
- H --- Hickory
- L --- Laminates
- M --- Maple
- O --- Oak
- QS --- Quartersawn
- U --- Unfinished

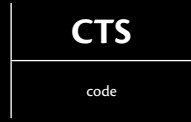

Valance backs are not finished.

Material thickness dimensions may be nominal based on lumber industry standards.

Specifications subject to change without notice.

### Countertop Support

(price book pg. L5)

#### CTS

Scalloped

#### CTS • S

Victorian

#### CTS • V

Victorian Plain

#### CTS • VP

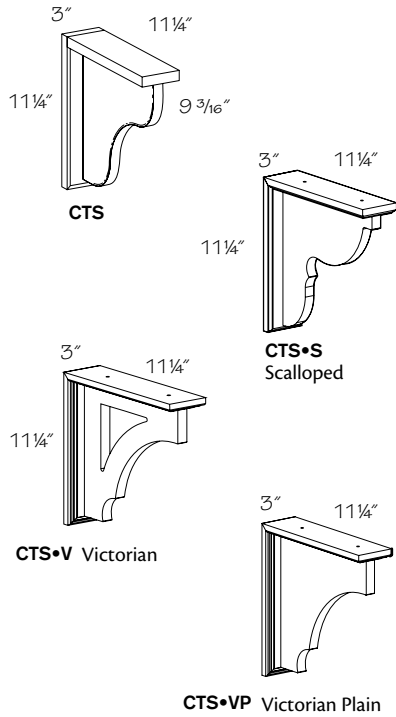

- 3/4" solid wood
- Laminates are painted hardwood
- For use when extra support for shelves or overhanging countertop is required
- ☆ Not available in Morristown; Melrose and Brockton are plain sawn wood

◆	B
◆	C
◆	H
◆	L
◆	M
◆	O
☆	QS
◆	U

### Mission Angle Support

(price book pg. L5)

#### MAS

Color coding indicates new product, size or code

- Solid wood
- Corner piece from shelf support bracket only
- Not available in Reduced Depth (RD)

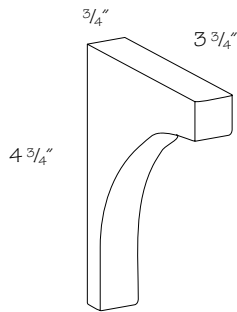

	B
◆	C
	H
	L
◆	M
	O
◆	QS
	U

### Mission Countertop Support

(price book pg. L5)

#### MCTS

Color coding indicates new product, size or code

- 3/4" solid wood
- For use when extra support for shelves or overhanging countertop is required
- Not available in Reduced Depth (RD)

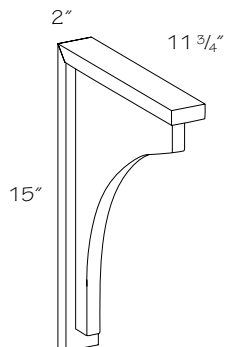

	B
◆	C
	H
	L
◆	M
	O
◆	QS
	U

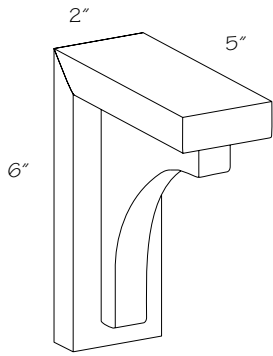

### Mission Shelf Support Bracket

(price book pg. L5)

#### MSSB

Color coding indicates new product, size or code

- Solid wood
- Not available in Reduced Depth (RD)

B
❖ C
H
L
❖ M
O
❖ QS
U

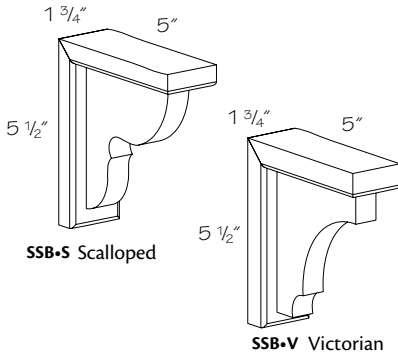

### Shelf Support Bracket

(price book pg. L5)

#### SSB ·S

#### SSB ·V

- Laminates are painted hardwood
- ☆ Not available in Morristown; Melrose and Brockton are plain sawn wood

❖ B
❖ C
❖ H
❖ L
❖ M
❖ O
☆ QS
❖ U



### Valance Frieze

(price book pg. L6)

#### Trim Valance (each end)

V18FR	3"	V24FR	3"
V27FR	4 1/8"	V30FR	2 1/4"
V33FR	3 3/4"	V36FR	1 13/16"
V42FR	4 3/4"	V48FR	4 3/8"
V54FR	4"	V60FR	3 5/8"
V66FR	3 1/8"	V72FR	3"
V81FR	7 1/4"	V84FR	2"

#### V18 FR

#### V24 FR

#### V27 FR

#### V30 FR

#### V33 FR

#### V36 FR

#### V42 FR

#### V48 FR

#### V54 FR

#### V60 FR

#### V66 FR

#### V72 FR

#### V81 FR

#### V84 FR

- 3/4" solid wood
- Laminates are painted hardwood
- Trimmable in field; see chart
- ☆ Not available in Morristown; Melrose and Brockton are plain sawn wood

❖ B
❖ C
❖ H
❖ L
❖ M
❖ O
☆ QS
❖ U

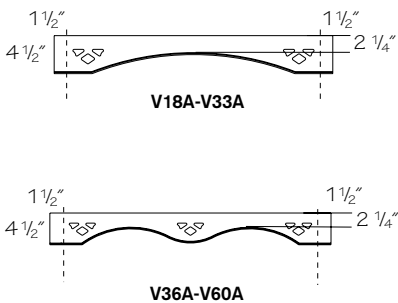

### Valance Arch Fret

(price book pg. L6)

#### V18 A

#### V21 A

#### V24 A

#### V27 A

#### V30 A

#### V33 A

#### V36 A

#### V39 A

#### V42 A

#### V45 A

#### V48 A

#### V51 A

#### V54 A

#### V57 A

#### V60 A

- 3/4" solid wood
- Laminates are painted hardwood
- Can be trimmed in field 1 1/2" each end
- ☆ Not available in Morristown; Melrose and Brockton are plain sawn wood

❖ B
❖ C
❖ H
❖ L
❖ M
❖ O
☆ QS
❖ U



### Valance Arch Mission

(price book pg. L6)

#### V30 A-M

#### V36 A-M

#### V42 A-M

#### V48 A-M

- 3/4" quartersawn solid wood
- Trimmable in field
- Available in quartersawn oak door styles only

B
C
H
L
M
O
❖ QS
U

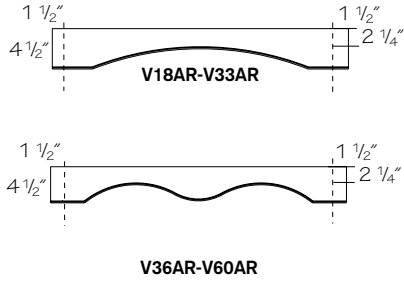

### Valance Arch No Fretwork

(price book pg. L6)

- |               |               |
|---------------|---------------|
| <b>V18 AR</b> | <b>V42 AR</b> |
| <b>V21 AR</b> | <b>V45 AR</b> |
| <b>V24 AR</b> | <b>V48 AR</b> |
| <b>V27 AR</b> | <b>V51 AR</b> |
| <b>V30 AR</b> | <b>V54 AR</b> |
| <b>V33 AR</b> | <b>V57 AR</b> |
| <b>V36 AR</b> | <b>V60 AR</b> |
| <b>V39 AR</b> |               |

- 3/4" solid wood
- Laminates are painted hardwood
- Can be trimmed in field 1 1/2" each end
- ☆ Not available in Morristown; Melrose and Brockton are plain sawn wood

❖	<b>B</b>
❖	<b>C</b>
❖	<b>H</b>
❖	<b>L</b>
❖	<b>M</b>
❖	<b>O</b>
❖	<b>QS</b>
❖	<b>U</b>

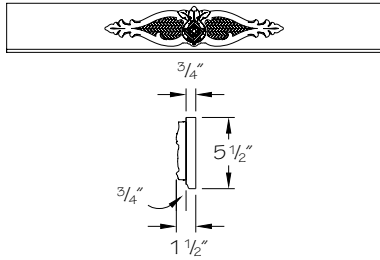

### Valance Casual

(price book pg. L6)

- |               |               |
|---------------|---------------|
| <b>V27 CA</b> | <b>V48 CA</b> |
| <b>V30 CA</b> | <b>V51 CA</b> |
| <b>V33 CA</b> | <b>V54 CA</b> |
| <b>V36 CA</b> | <b>V57 CA</b> |
| <b>V39 CA</b> | <b>V60 CA</b> |
| <b>V42 CA</b> |               |
| <b>V45 CA</b> |               |

- Solid wood
- Trimmable in field
- Applied casual ornament

<b>B</b>
<b>C</b>
<b>H</b>
<b>L</b>
❖ <b>M</b>
<b>O</b>
<b>QS</b>
<b>U</b>

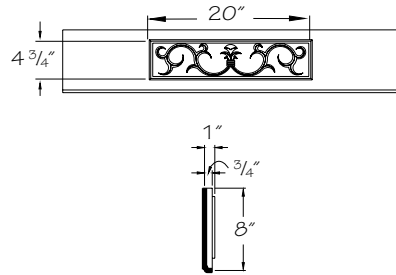

### Valance Classic

(price book pg. L6)

- |               |               |
|---------------|---------------|
| <b>V27 CL</b> | <b>V45 CL</b> |
| <b>V30 CL</b> | <b>V48 CL</b> |
| <b>V33 CL</b> | <b>V51 CL</b> |
| <b>V36 CL</b> | <b>V54 CL</b> |
| <b>V39 CL</b> | <b>V57 CL</b> |
| <b>V42 CL</b> | <b>V60 CL</b> |

- Solid wood
- Trimmable in field
- Black resin insert

<b>B</b>
❖ <b>C</b>
<b>H</b>
<b>L</b>
<b>M</b>
<b>O</b>
<b>QS</b>
<b>U</b>

### Valance Cove

(price book pg. L6)

- |               |               |                 |                 |
|---------------|---------------|-----------------|-----------------|
| 5 1/2" high   | 5 1/2" high   | 8" high         | 8" high         |
| <b>V18 CV</b> | <b>V60 CV</b> | <b>V1808 CV</b> | <b>V6008 CV</b> |
| <b>V21 CV</b> | <b>V63 CV</b> | <b>V2108 CV</b> | <b>V6308 CV</b> |
| <b>V24 CV</b> | <b>V66 CV</b> | <b>V2408 CV</b> | <b>V6608 CV</b> |
| <b>V27 CV</b> | <b>V69 CV</b> | <b>V2708 CV</b> | <b>V6908 CV</b> |
| <b>V30 CV</b> | <b>V72 CV</b> | <b>V3008 CV</b> | <b>V7208 CV</b> |
| <b>V33 CV</b> | <b>V75 CV</b> | <b>V3308 CV</b> | <b>V7508 CV</b> |
| <b>V36 CV</b> | <b>V78 CV</b> | <b>V3608 CV</b> | <b>V7808 CV</b> |
| <b>V39 CV</b> | <b>V81 CV</b> | <b>V3908 CV</b> | <b>V8108 CV</b> |
| <b>V42 CV</b> | <b>V84 CV</b> | <b>V4208 CV</b> | <b>V8408 CV</b> |
| <b>V45 CV</b> | <b>V87 CV</b> | <b>V4508 CV</b> | <b>V8708 CV</b> |
| <b>V48 CV</b> | <b>V90 CV</b> | <b>V4808 CV</b> | <b>V9008 CV</b> |
| <b>V51 CV</b> | <b>V93 CV</b> | <b>V5108 CV</b> | <b>V9308 CV</b> |
| <b>V54 CV</b> | <b>V96 CV</b> | <b>V5408 CV</b> | <b>V9608 CV</b> |
| <b>V57 CV</b> |               | <b>V5708 CV</b> |                 |

- 3/4" solid wood
- Laminates are painted hardwood
- Can be trimmed in field 1 1/2" each end, but will compromise design by reducing height
- ☆ Not available in Morristown; Melrose and Brockton are plain sawn wood



❖ <b>B</b>
❖ <b>C</b>
❖ <b>H</b>
❖ <b>L</b>
❖ <b>M</b>
❖ <b>O</b>
❖ <b>QS</b>
❖ <b>U</b>

### Valance Crown

(price book pg. L7)

5 1/2" high	5 1/2" high	8" high	8" high
<b>V18 CR</b>	<b>V60 CR</b>	<b>V1808 CR</b>	<b>V6008 CR</b>
<b>V21 CR</b>	<b>V63 CR</b>	<b>V2108 CR</b>	<b>V6308 CR</b>
<b>V24 CR</b>	<b>V66 CR</b>	<b>V2408 CR</b>	<b>V6608 CR</b>
<b>V27 CR</b>	<b>V69 CR</b>	<b>V2708 CR</b>	<b>V6908 CR</b>
<b>V30 CR</b>	<b>V72 CR</b>	<b>V3008 CR</b>	<b>V7208 CR</b>
<b>V33 CR</b>	<b>V75 CR</b>	<b>V3308 CR</b>	<b>V7508 CR</b>
<b>V36 CR</b>	<b>V78 CR</b>	<b>V3608 CR</b>	<b>V7808 CR</b>
<b>V39 CR</b>	<b>V81 CR</b>	<b>V3908 CR</b>	<b>V8108 CR</b>
<b>V42 CR</b>	<b>V84 CR</b>	<b>V4208 CR</b>	<b>V8408 CR</b>
<b>V45 CR</b>	<b>V87 CR</b>	<b>V4508 CR</b>	<b>V8708 CR</b>
<b>V48 CR</b>	<b>V90 CR</b>	<b>V4808 CR</b>	<b>V9008 CR</b>
<b>V51 CR</b>	<b>V93 CR</b>	<b>V5108 CR</b>	<b>V9308 CR</b>
<b>V54 CR</b>	<b>V96 CR</b>	<b>V5408 CR</b>	<b>V9608 CR</b>
<b>V57 CR</b>		<b>V5708 CR</b>	

- 3/4" solid wood
- Laminates are painted hardwood
- Can be trimmed in field 1 1/2" each end
- ☆ Not available in Morristown; Melrose and Brockton are plain sawn wood

❖	<b>B</b>
❖	<b>C</b>
❖	<b>H</b>
❖	<b>L</b>
❖	<b>M</b>
❖	<b>O</b>
●	<b>QS</b>
❖	<b>U</b>

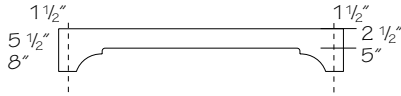

### Valance Traditional

(price book pg. L7)

5 1/2" high	8" high
<b>V18 T</b>	<b>V1808 T</b>
<b>V24 T</b>	<b>V2408 T</b>
<b>V30 T</b>	<b>V3008 T</b>
<b>V36 T</b>	<b>V3608 T</b>
<b>V48 T</b>	<b>V4808 T</b>
<b>V60 T</b>	<b>V6008 T</b>
<b>V72 T</b>	<b>V7208 T</b>
<b>V84 T</b>	<b>V8408 T</b>
<b>V96 T</b>	<b>V9608 T</b>

- 3/4" solid wood
- Laminates are painted hardwood
- Trimmable in field
- Can be used as furniture valance
- ☆ Not available in Morristown; Melrose and Brockton are plain sawn wood

❖	<b>B</b>
❖	<b>C</b>
❖	<b>H</b>
❖	<b>L</b>
❖	<b>M</b>
❖	<b>O</b>
☆	<b>QS</b>
❖	<b>U</b>

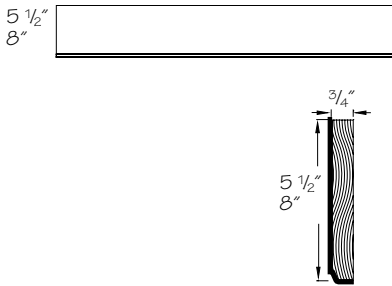

### Valance Furniture

(price book pg. L7)

5 1/2" high	5 1/2" high	8" high	8" high
<b>V18 F</b>	<b>V60 F</b>	<b>V1808 F</b>	<b>V6008 F</b>
<b>V21 F</b>	<b>V63 F</b>	<b>V2108 F</b>	<b>V6308 F</b>
<b>V24 F</b>	<b>V66 F</b>	<b>V2408 F</b>	<b>V6608 F</b>
<b>V27 F</b>	<b>V69 F</b>	<b>V2708 F</b>	<b>V6908 F</b>
<b>V30 F</b>	<b>V72 F</b>	<b>V3008 F</b>	<b>V7208 F</b>
<b>V33 F</b>	<b>V75 F</b>	<b>V3308 F</b>	<b>V7508 F</b>
<b>V36 F</b>	<b>V78 F</b>	<b>V3608 F</b>	<b>V7808 F</b>
<b>V39 F</b>	<b>V81 F</b>	<b>V3908 F</b>	<b>V8108 F</b>
<b>V42 F</b>	<b>V84 F</b>	<b>V4208 F</b>	<b>V8408 F</b>
<b>V45 F</b>	<b>V87 F</b>	<b>V4508 F</b>	<b>V8708 F</b>
<b>V48 F</b>	<b>V90 F</b>	<b>V4808 F</b>	<b>V9008 F</b>
<b>V51 F</b>	<b>V93 F</b>	<b>V5108 F</b>	<b>V9308 F</b>
<b>V54 F</b>	<b>V96 F</b>	<b>V5408 F</b>	<b>V9608 F</b>
<b>V57 F</b>		<b>V5708 F</b>	

- 3/4" solid wood
- Laminates are painted hardwood
- Can be trimmed in field 1 1/2" each end
- ☆ Not available in Morristown; Melrose and Brockton are plain sawn wood

❖	<b>B</b>
❖	<b>C</b>
❖	<b>H</b>
❖	<b>L</b>
❖	<b>M</b>
❖	<b>O</b>
☆	<b>QS</b>
❖	<b>U</b>

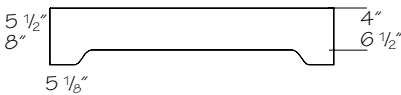

### Valance Scalloped

(price book pg. L8)

5 1/2" high

8" high

<b>V18 S</b>	<b>V1808 S</b>
<b>V24 S</b>	<b>V2408 S</b>
<b>V30 S</b>	<b>V3008 S</b>
<b>V36 S</b>	<b>V3608 S</b>
<b>V48 S</b>	<b>V4808 S</b>
<b>V60 S</b>	<b>V6008 S</b>
<b>V72 S</b>	<b>V7208 S</b>
<b>V84 S</b>	<b>V8408 S</b>
<b>V96 S</b>	<b>V9608 S</b>



- 3/4" solid wood
- Laminates are painted hardwood
- Trimmable in field
- ☆ Not available in Morristown; Melrose and Brockton are plain sawn wood

❖	<b>B</b>
❖	<b>C</b>
❖	<b>H</b>
❖	<b>L</b>
❖	<b>M</b>
❖	<b>O</b>
☆	<b>QS</b>
❖	<b>U</b>

### Valance Corbel

(price book pg. L8)

5 1/2" high

5 1/2" high

8" high

8" high

<b>V18 CB</b>	<b>V60 CB</b>	<b>V1808 CB</b>	<b>V6008 CB</b>
<b>V21 CB</b>	<b>V63 CB</b>	<b>V2108 CB</b>	<b>V6308 CB</b>
<b>V24 CB</b>	<b>V66 CB</b>	<b>V2408 CB</b>	<b>V6608 CB</b>
<b>V27 CB</b>	<b>V69 CB</b>	<b>V2708 CB</b>	<b>V6908 CB</b>
<b>V30 CB</b>	<b>V72 CB</b>	<b>V3008 CB</b>	<b>V7208 CB</b>
<b>V33 CB</b>	<b>V75 CB</b>	<b>V3308 CB</b>	<b>V7508 CB</b>
<b>V36 CB</b>	<b>V78 CB</b>	<b>V3608 CB</b>	<b>V7808 CB</b>
<b>V39 CB</b>	<b>V81 CB</b>	<b>V3908 CB</b>	<b>V8108 CB</b>
<b>V42 CB</b>	<b>V84 CB</b>	<b>V4208 CB</b>	<b>V8408 CB</b>
<b>V45 CB</b>	<b>V87 CB</b>	<b>V4508 CB</b>	<b>V8708 CB</b>
<b>V48 CB</b>	<b>V90 CB</b>	<b>V4808 CB</b>	<b>V9008 CB</b>
<b>V51 CB</b>	<b>V93 CB</b>	<b>V5108 CB</b>	<b>V9308 CB</b>
<b>V54 CB</b>	<b>V96 CB</b>	<b>V5408 CB</b>	<b>V9608 CB</b>
<b>V57 CB</b>		<b>V5708 CB</b>	

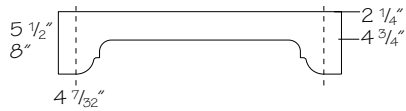

- 3/4" solid wood
- Can be trimmed in field 1 1/2" each end
- Laminates are painted hardwood
- ☆ Not available in Morristown; Melrose and Brockton are plain sawn wood

❖	<b>B</b>
❖	<b>C</b>
❖	<b>H</b>
❖	<b>L</b>
❖	<b>M</b>
❖	<b>O</b>
☆	<b>QS</b>
❖	<b>U</b>

### Valance Shaker

(price book pg. L8)

5 1/2" high

5 1/2" high

8" high

8" high

<b>V18 SH</b>	<b>V60 SH</b>	<b>V1808 SH</b>	<b>V6008 SH</b>
<b>V21 SH</b>	<b>V63 SH</b>	<b>V2108 SH</b>	<b>V6308 SH</b>
<b>V24 SH</b>	<b>V66 SH</b>	<b>V2408 SH</b>	<b>V6608 SH</b>
<b>V27 SH</b>	<b>V69 SH</b>	<b>V2708 SH</b>	<b>V6908 SH</b>
<b>V30 SH</b>	<b>V72 SH</b>	<b>V3008 SH</b>	<b>V7208 SH</b>
<b>V33 SH</b>	<b>V75 SH</b>	<b>V3308 SH</b>	<b>V7508 SH</b>
<b>V36 SH</b>	<b>V78 SH</b>	<b>V3608 SH</b>	<b>V7808 SH</b>
<b>V39 SH</b>	<b>V81 SH</b>	<b>V3908 SH</b>	<b>V8108 SH</b>
<b>V42 SH</b>	<b>V84 SH</b>	<b>V4208 SH</b>	<b>V8408 SH</b>
<b>V45 SH</b>	<b>V87 SH</b>	<b>V4508 SH</b>	<b>V8708 SH</b>
<b>V48 SH</b>	<b>V90 SH</b>	<b>V4808 SH</b>	<b>V9008 SH</b>
<b>V51 SH</b>	<b>V93 SH</b>	<b>V5108 SH</b>	<b>V9308 SH</b>
<b>V54 SH</b>	<b>V96 SH</b>	<b>V5408 SH</b>	<b>V9608 SH</b>
<b>V57 SH</b>		<b>V5708 SH</b>	

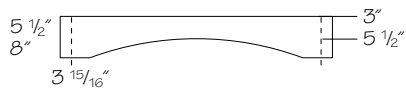

- 3/4" solid wood
- Laminates are painted hardwood
- Can be trimmed in field 1 1/2" each end
- ☆ Not available in Morristown; Melrose and Brockton are plain sawn wood

❖	<b>B</b>
❖	<b>C</b>
❖	<b>H</b>
❖	<b>L</b>
❖	<b>M</b>
❖	<b>O</b>
☆	<b>QS</b>
❖	<b>U</b>

### Valance Victorian

(price book pg. L8)

5 1/2" high	5 1/2" high	8" high	8" high
<b>V18 V</b>	<b>V60 V</b>	<b>V1808 V</b>	<b>V6008 V</b>
<b>V21 V</b>	<b>V63 V</b>	<b>V2108 V</b>	<b>V6308 V</b>
<b>V24 V</b>	<b>V66 V</b>	<b>V2408 V</b>	<b>V6608 V</b>
<b>V27 V</b>	<b>V69 V</b>	<b>V2708 V</b>	<b>V6908 V</b>
<b>V30 V</b>	<b>V72 V</b>	<b>V3008 V</b>	<b>V7208 V</b>
<b>V33 V</b>	<b>V75 V</b>	<b>V3308 V</b>	<b>V7508 V</b>
<b>V36 V</b>	<b>V78 V</b>	<b>V3608 V</b>	<b>V7808 V</b>
<b>V39 V</b>	<b>V81 V</b>	<b>V3908 V</b>	<b>V8108 V</b>
<b>V42 V</b>	<b>V84 V</b>	<b>V4208 V</b>	<b>V8408 V</b>
<b>V45 V</b>	<b>V87 V</b>	<b>V4508 V</b>	<b>V8708 V</b>
<b>V48 V</b>	<b>V90 V</b>	<b>V4808 V</b>	<b>V9008 V</b>
<b>V51 V</b>	<b>V93 V</b>	<b>V5108 V</b>	<b>V9308 V</b>
<b>V54 V</b>	<b>V96 V</b>	<b>V5408 V</b>	<b>V9608 V</b>
<b>V57 V</b>		<b>V5708 V</b>	

- 3/4" solid wood
- Laminates are painted hardwood
- Can be trimmed in field 1 1/2" each end
- ☆ Not available in Morristown; Melrose and Brockton are plain sawn wood

❖	B
❖	C
❖	H
❖	L
❖	M
❖	O
☆	QS
❖	U

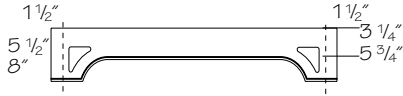

### Valance Contemporary

(price book pg. L9)

5 1/2" high	8" high
<b>V18 C</b>	<b>V1808 C</b>
<b>V24 C</b>	<b>V2408 C</b>
<b>V30 C</b>	<b>V3008 C</b>
<b>V36 C</b>	<b>V3608 C</b>
<b>V48 C</b>	<b>V4808 C</b>
<b>V60 C</b>	<b>V6008 C</b>
<b>V72 C</b>	<b>V7208 C</b>
<b>V84 C</b>	<b>V8408 C</b>
<b>V96 C</b>	<b>V9608 C</b>

- 3/4" solid wood
- Laminates are painted hardwood
- Trimmable in field
- ☆ Not available in Morristown; Melrose and Brockton are plain sawn wood

❖	B
❖	C
❖	H
❖	L
❖	M
❖	O
☆	QS
❖	U

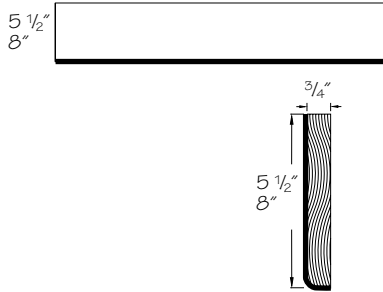

### Valance Raised Panel

(price book pg. L9)

<b>V30 RP</b>
<b>V36 RP</b>
<b>V42 RP</b>
<b>V48 RP</b>
<b>V54 RP</b>
<b>V60 RP</b>

- 3/4" solid wood
- Laminates are painted hardwood
- Not trimmable
- ☆ Not available in Morristown; Melrose and Brockton are plain sawn wood

❖	B
❖	C
❖	H
❖	L
❖	M
❖	O
☆	QS
❖	U

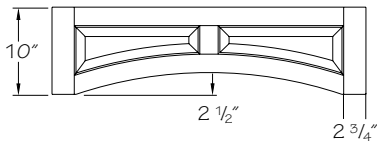

### Valance Flat Panel

(price book pg. L9)

<b>V30 FP</b>
<b>V36 FP</b>
<b>V42 FP</b>
<b>V48 FP</b>
<b>V54 FP</b>
<b>V60 FP</b>

- 3/4" solid wood
- Laminates are painted hardwood
- Not trimmable
- ☆ Not available in Morristown; Melrose and Brockton are plain sawn wood

❖	B
❖	C
❖	H
❖	L
❖	M
❖	O
☆	QS
❖	U

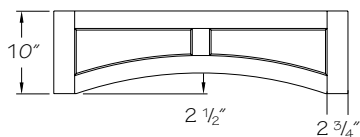

**Valance Slat**

*(price book pg. L9)*

**V24 SL•M**

**V30 SL•M**

**V36 SL•M**

**V42 SL•M**

**V48 SL•M**

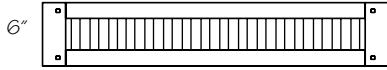

- 3/4" quartersawn solid wood
- Trimmable in field
- Available in Morristown door style only

B
C
H
L
M
O
❖ QS
U

**Valance Straight**

*(price book pg. L9)*

**V18 ST**

**V24 ST**

**V30 ST**

**V36 ST**

**V42 ST**

**V48 ST**

**V60 ST**

**V72 ST**

**V84 ST**



- 3/4" solid wood
- Trimmable in field

B
❖ C
H
L
❖ M
O
❖ QS
U

*Color coding indicates new product, size or code*